





# TEST REPORT

 <b>CTK Co., Ltd.</b> <small>The Power Leader of Global Regulatory Certification</small>	<b>CTK Co., Ltd.</b> (5 Dongbu-ro 221beon-gil, Cheoin-gu, Yongin-si, Gyeonggi-do, Republic of Korea Tel: +82-31-339-9970 Fax: +82-31-624-9501	REPORT No.: CTK-K-2023-00298 Page (1) / (16) pages	 KOLAS TESTING NO. KT119
---	---	--	---

<b>1. Applicant</b> Name ..... : HANYOUNG NUX CO.,LTD Address ..... : 28, Gilpa-ro 71 beon-gil, Michuhol-gu, Incheon, Korea Date of Receipt ..... : 2023-02-06		
<b>2. Manufacturer</b> Name..... : PT. HANYOUNG ELECTRONIC INDONESIA Address ..... : JL. JANGARI RT.003 RW.002 DESA HEGARMANAH SUKALUYU, CIANJUR, JAWA BARAT, INDONESIA		
<b>3. Use of Report</b> ..... : Quality control		
<b>4. Test sample / Model</b> ..... : Power Switch / BEWT315		
<b>5. Date(s) of test</b> ..... : 2023-02-10 ~ 2023-02-23		
<b>6. Test Standard (Method) used</b> .. : IEC 60529:1989 +A1:1999+A2:2013		
<b>7. Testing Environment</b> ..... : Temperature: (25.0 ± 10.0) °C, Humidity: (50 ± 25) %R.H., Air Pressure: (99.0 ± 2) kPa		
<b>8. Test Results</b> ..... : Reference test results		
<b>9. Location of Test</b> ..... : <input checked="" type="checkbox"/> Permanent Testing Lab <input type="checkbox"/> On Site Testing (Address : (Ho-dong), 113, Yejik-ro, Cheoin-gu, Yongin-si, Gyeonggi-do, 449-100, Korea)		
The results shown in this test report refer only to the sample(s) tested unless otherwise stated. This report cannot be reproduced or copied without the written consent of CTK		
Approval	Tested by : JaeYoon Sim  (Signature)	Technical Manager: HyunSeob Lim  (Signature)
2023-02-28		
 <b>CTK Co., Ltd.</b>		

## 1. Degrees of protection provided by enclosures (IP code)

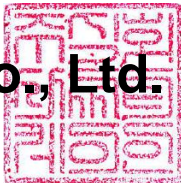
### 1.1 Test standard: IEC 60529:1989 +A1:1999+A2:2013

### 1.2 Arrangement of the IP code

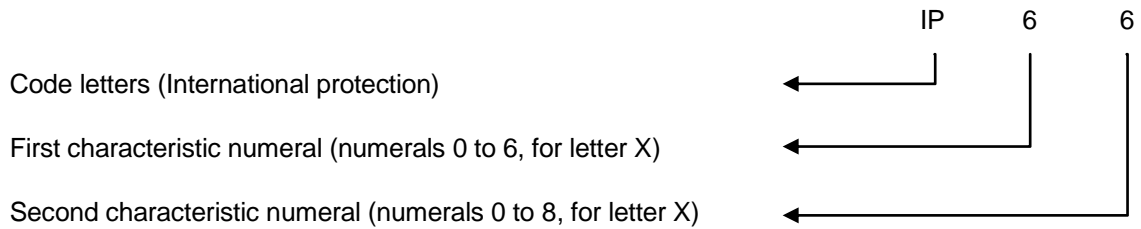

#### 1.2.1 Degree of protection against access to hazardous parts indicated by the first characteristic numeral

First characteristic numeral	Degree of protection	Application
0	Non-protected	<input type="checkbox"/>
1	Protected against access to hazardous parts with the back of a hand. The access probe, sphere of 50 mmØ, shall have adequate clearance from hazardous parts. Test force: 50 N ± 10 %	<input type="checkbox"/>
2	Protected against access to hazardous parts with a finger. The jointed test finger of 12 mmØ, 80 mm length, shall have adequate clearance from hazardous parts. Test force: 10 N ± 10 %	<input type="checkbox"/>
3	Protected against access to hazardous parts with a tool. The access probe of 2.5 mmØ, shall not penetrate. Test force: 3 N ± 10 %	<input type="checkbox"/>
4	Protected against access to hazardous parts with a wire. The access probe of 1.0 mmØ, shall not penetrate. Test force: 1 N ± 10 %	<input type="checkbox"/>
5	Protected against access to hazardous parts with a wire. The access probe of 1.0 mmØ, shall not penetrate. Test force: 1 N ± 10 %	<input type="checkbox"/>

First characteristic numeral	Degree of protection	Application
6	Protected against access to hazardous parts with a wire. The access probe of 1.0 mmØ, shall not penetrate. Test force: 1 N ± 10 %	<input checked="" type="checkbox"/>

NOTE In the case of the first characteristic numerals 3, 4, 5 and 6, protection against access to hazardous parts is satisfied if adequate clearance is kept. The adequate clearance should be specified by the relevant product committee in accordance with 12.3. Due to the simultaneous requirement specified in table 2, the definition “shall not penetrate” is given in table 1.

### 1.2.2 Degree of protection against solid foreign objects indicated by the first characteristic numeral

First characteristic numeral	Degree of protection	Application
0	Non-protected	<input type="checkbox"/>
1	Protected against solid foreign objects of 50 mmØ and greater. The object probe, sphere of 50 mmØ, shall not fully penetrate <sup>1)</sup> . Test force: 50 N ± 10 %	<input type="checkbox"/>
2	Protected against solid foreign objects of 12.5 mmØ and greater. The object probe, sphere of 12.5 mmØ, shall not fully penetrate <sup>1)</sup> . Test force: 30 N ± 10 %	<input type="checkbox"/>
3	Protected against solid foreign objects of 2.5 mmØ and greater. The object probe, sphere of 2.5 mmØ, shall not penetrate at all <sup>1)</sup> . Test force: 3 N ± 10 %	<input type="checkbox"/>
4	Protected against solid foreign objects of 1.0 mmØ and greater. The object probe, sphere of 1.0 mmØ, shall not penetrate at all <sup>1)</sup> . Test force: 1 N ± 10 %	<input type="checkbox"/>
5	Dust Testing Equipment Whether reductions in pressure below the atmospheric pressure are present or not, ingress of dust is not totally preventive, but dust shall not penetrate in a quantity to interfere with satisfactory operation of the apparatus or to impair safety. (Talcum powder have to go through the measured sieve by Φ 50 um wire that are spacing 75 um in squared, per volume and union Talcum powder have to be 2 kg/m <sup>3</sup> )	—



### 1.2.3 Degrees of protection against water indicated by the second characteristic numeral

Second characteristic numeral	Degrees of protection	Application
0	Non-protected	<input type="checkbox"/>
1	<p>Water that drops vertically has to be harmless</p> <p>Drip box Fig.3, Enclosure on turntable</p> <p>Water flow rate: 1 mm/min</p> <p>Speed of Rotating platform: 1 r/min</p> <p>Eccentricity: Approximately 100 mm</p> <p>Duration of test: 10 min</p>	<input type="checkbox"/>
2	<p>When outskirts of the product have been tilted by 15° Water that drops vertically has to be harmless.</p> <p>Drip box Fig.3, Enclosure in 4 fixed positions of 15° tilt</p> <p>Water flow rate: 3 mm/min</p> <p>Duration of test: 2.5 min for each position of tilt</p>	<input type="checkbox"/>
3	<p>Vertical line of water that moves by <math>\pm 60^\circ</math> and its drops has to be harmless</p> <p><input type="checkbox"/> Oscillating tube Fig.4, Spray <math>\pm 60^\circ</math> from vertical, Distance max. 200 mm Water flow rate: each of watering pit 0.07 l/min <math>\pm 5\%</math> per hole Duration of test: 10 min</p> <p><input type="checkbox"/> spray nozzle Fig. 5, Spray <math>\pm 60^\circ</math> from vertical Water flow rate: 10 l/min <math>\pm 5\%</math> Duration of test: 1 min/m<sup>2</sup> at least 5 min: <b>min</b></p>	<input type="checkbox"/>
4	<p>The product must not be harmed in any direction even splashing water.</p> <p>As for numeral 3, Spray <math>\pm 180^\circ</math> from vertical</p> <p><input type="checkbox"/> Oscillating tube Fig.4, Spray <math>\pm 180^\circ</math> from vertical, Distance max. 200 mm Water flow rate: each of watering pit 0.07 l/min <math>\pm 5\%</math> per hole Duration of test: 10 min</p> <p><input type="checkbox"/> spray nozzle Fig. 5, Spray <math>\pm 180^\circ</math> from vertical Water flow rate: 10 l/min <math>\pm 5\%</math> Duration of test: 1 min/m<sup>2</sup> at least 5 min: <b>min</b></p>	<input type="checkbox"/>



**CTK Co., Ltd.**

(5 Dongbu-ro 221beon-gil, Cheoin-gu, Yongin-si,  
Gyeonggi-do, Republic of Korea  
Tel: +82-31-339-9970  
Fax: +82-31-624-9501

REPORT No.:  
CTK-K-2023-00298  
Page (6) / (16) pages



Second characteristic numeral	Degrees of protection	Application
5	<p>The product must not be harmed in any direction even a single jet water.</p> <p>Water jet hose nozzle Fig.6, Nozzle 6.3 mm diameter</p> <p>Water flow rate: 12.5 l/min ± 5 %      <b>LPM</b></p> <p>Distance: 2.5 m to 3 m:      <b>m</b></p> <p>Duration of test: 1 min/m<sup>2</sup> at least 3 min :      <b>min</b></p>	<input type="checkbox"/>
6	<p>The product must not be harmed in any direction even strong jet water.</p> <p>Water jet hose nozzle Fig.6, Nozzle 12.5 mm diameter</p> <p>Water flow rate: 100 /min ± 5 % <b>100 LPM</b></p> <p>Distance: 2.5 m to 3 m: <b>3 m</b></p> <p>Duration of test: 1 min/m<sup>2</sup> at least 3 min : <b>3 min</b></p>	<input checked="" type="checkbox"/>
7	<p>Sink the product in the water by the Pressure and Time according to regulation and the product must not be harmed.</p> <p>Immersion tank water-level on enclosure with:</p> <p><input type="checkbox"/> height equal to or greater than 850 mm: the highest point of enclosures located 0.15 m below the surface of the water</p> <p><input type="checkbox"/> height less than 850 mm: the lowest point of enclosures located 1 m below the surface of the water</p> <p>Duration of test: 30 min</p>	<input type="checkbox"/>
8	<p>Unless there is a relevant product standard, the test conditions are subject to agreement between manufacturer and user, but they shall be more severe than those prescribed in IP X7 and they shall take account of the condition that the enclosure will be continuously immersed in actual use.</p> <p>the lowest point of enclosures located below the surface of the water:</p> <p style="text-align: center;"><b>m</b></p> <p>Duration of test:      <b>min</b></p>	<input type="checkbox"/>

### 1.3 Test Result

IP code	Remark
IP 6X	No penetration of probe No ingress of dust
IP X6	No ingress of water.

※ The results shown in this test report refer only to the sample(s) tested unless otherwise stated



**CTK Co., Ltd.**

(5 Dongbu-ro 221beon-gil, Cheoin-gu, Yongin-si,  
Gyeonggi-do, Republic of Korea  
Tel: +82-31-339-9970  
Fax: +82-31-624-9501

REPORT No.:  
CTK-K-2023-00298  
Page (8) / (16) pages



**List of test equipment used:**

Instr. No.	Instrument type	Model	Make	Serial	Used
S3-T11	Sphere 50 mm diameter	IEC60529 IP1X	Kingpo	KP-TP001	<input type="checkbox"/>
S1-J10	Jointed test finger	TFP-01	ED&D	-	<input type="checkbox"/>
S1-J14	Test rod (2.5 mm)	TRP-01	ED&D	-	<input type="checkbox"/>
S1-J15	Test wire (1.0 mm)	TRP-02	ED&D	-	<input checked="" type="checkbox"/>
C-S1-X01	Push Pull Gage	FB30K	Imada	83805	<input checked="" type="checkbox"/>
S3-IP36	Dust Chamber	NONE	JFM	-	<input checked="" type="checkbox"/>
S1-J19-1	ANGLE METER	AM-01	ED&D	CTK-IN-S1-154	<input type="checkbox"/>
S5-IP04	Water flow meter with Drip box	M-15	LZT	200971	<input type="checkbox"/>
S5-IP04-1	Drip box	IEC 60529 Drip Box, IPX1/ IPX2	Kingpo	ZH13388-1	<input type="checkbox"/>
S5-IP05-1	Oscillating Tube	IEC 60529 oscillating tube, with rotate table, IPX3/ IPX4	Kingpo	-	<input type="checkbox"/>
S5-IP05-2	Water flow meter with IPX3,IPX4	LZT-1002M	NBDC	14081690	<input type="checkbox"/>
S5-IP05-3	Spray Nozzle	IEC 60529 Spray Nozzle	Kingpo	-	<input type="checkbox"/>
S5-IP06	Hose Nozzle (6.3 mm)	IPX5	Kingpo	ZH13388	<input type="checkbox"/>
S5-IP06-1	Water flow meter with IPX5	LZT-1005M	NBDC	14121925	<input type="checkbox"/>
S5-IP07	Hose Nozzle (12.5 mm)	IPX6	Kingpo	ZH13388	<input checked="" type="checkbox"/>
S5-IP07-2	Water flow meter with IPX6	M-25	LZT	1903	<input checked="" type="checkbox"/>
S5-IP08	Immersion tank	Cage for IPX7/IPX8	Kingpo	-	<input type="checkbox"/>
S5-P01	Digital Power Meter	WT210	Yokogawa	96F302605	<input type="checkbox"/>
S5-W01	Withstanding voltage tester	TOS5051	KIKUSUI	HC002133	<input type="checkbox"/>
S5-SW1	Stop Watch	NONE	TOPPA	-	<input checked="" type="checkbox"/>
C-S1-H05	Aneroid Barometer	BAROMEX	SATO	84682	<input checked="" type="checkbox"/>
S5-H06	Hygro Thermograph	ST-50M	SEKONIC	HE51-000147	<input checked="" type="checkbox"/>



## 2. APPENDIX

### 2.1 Product Photographs

< Photo 1 > Product External view



< Photo 2 > Product External view



< Photo 3 > Product External view



## 2.2 Test Setup Photos and Configuration

< Photo 4 > The first characteristic numeral test



< Photo 5 > The second characteristic numeral test



## 2.3 Product internal photographs after test

< Photo 6 > The first characteristic numeral test

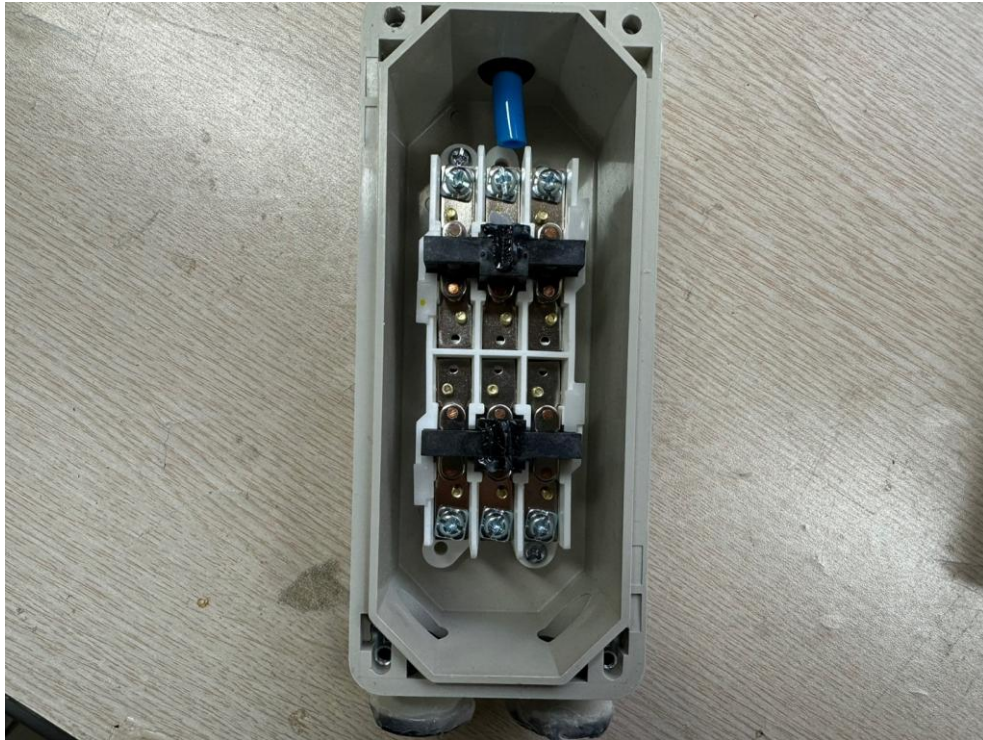

< Photo 7 > The first characteristic numeral test



< Photo 8 > The first characteristic numeral test

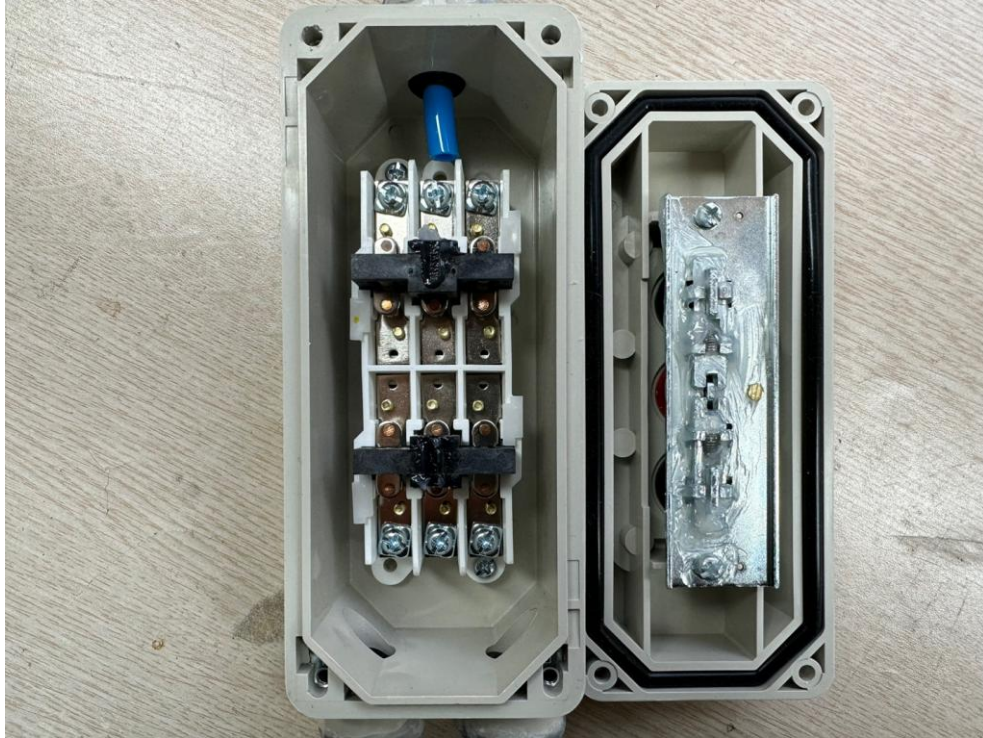

< Photo 9 > The second characteristic numeral test



< Photo 10 > The second characteristic numeral test



< Photo 11 > The second characteristic numeral test



## 2.4 Product Appearance

### Enclosure Dimensions

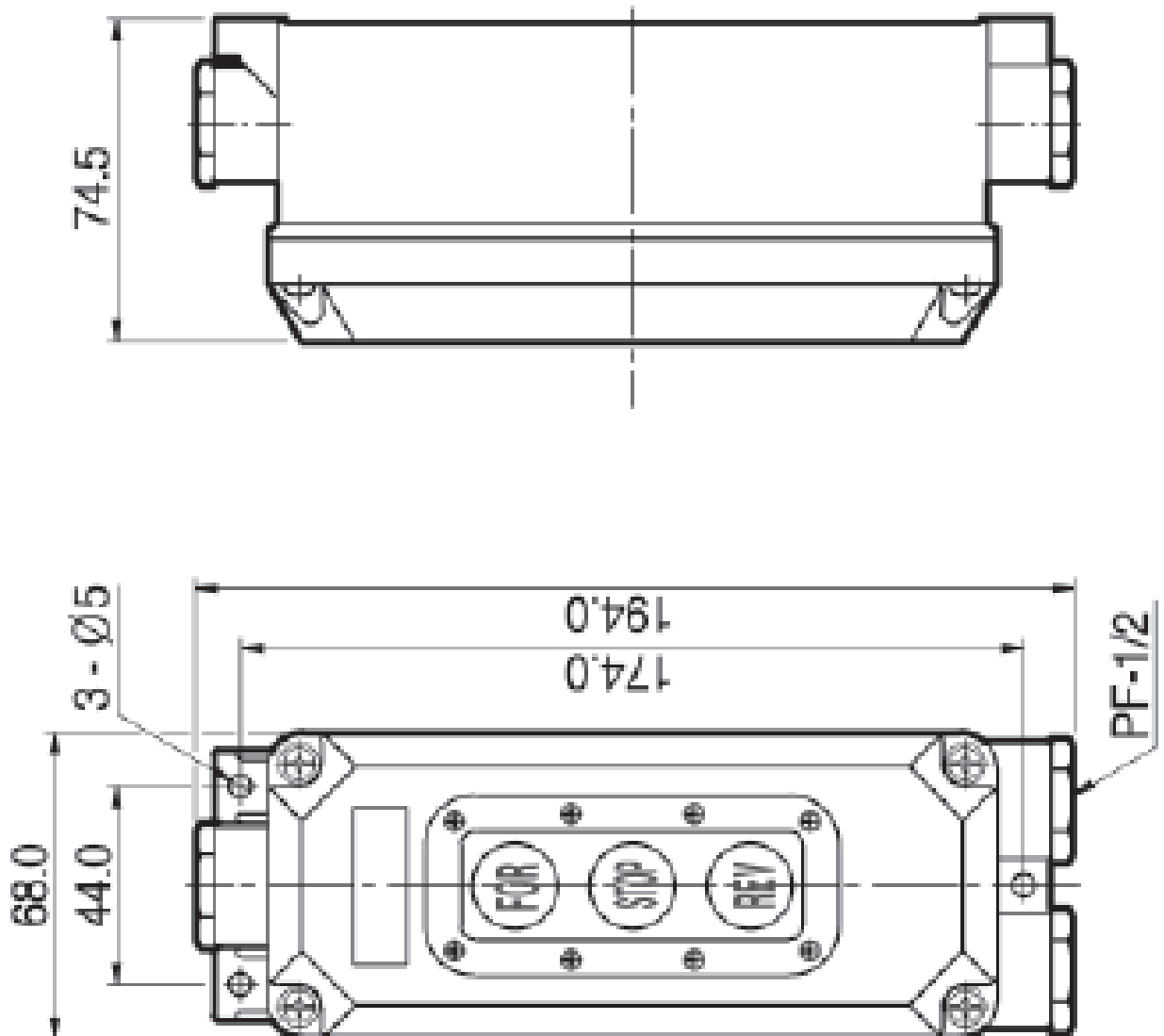

-END-