

LCD weekly/yearly time switch

LY4

Manual



Table of contents

1. Before start	1.1 Safety information	5
2. Suffix code		6
3. Specification		7
4. Appearance and panel cutout dimension		8
5. Connection diagram		9
6. Output connection		9
7. Front panel composition	7.1 LCD display	10
	7.2 Front panel	11
8. Flush panel type/exposed type converting method		12
9. Function explanation	9.1 Operation function explanation	13
	9.2 Operation explanation	15
10. Parameter formation		15
11. Time adjusting method		16
12. Setting group formation	12.1 Program set group formation	18
	12.2 Function set group formation	19
13. Program setting	13.1 Normal timer operation	20
	13.2 Days timer operation	21
	13.3 Next day timer operation	23
	13.4 Weekly pulse operation	24
	13.5 Weekly cycle operation	25
	13.6 Yearly timer operation	27
	13.7 Yearly pulse operation	29
14. Program editing	14.1 Weekly program edit	30
	14.2 Yearly program edit	31

15. Delete all programs	15.1 Delete all weekly programs	32
	15.2 Delete all yearly programs	32
16. Program test		32
17. Function setting	17.1 Current time setting	33
	17.2 Yearly holiday setting	33
	17.3 Season switch setting	34
	17.4 Summer time setting	36
18. Simple function	18.1 Summer time external input	38
	18.2 12/24h indication switch	39
	18.3 Screen display switch	39

1 Before start

Thank you for purchasing our product.

This manual clearly explains about the function of product, How to install, How to use, precautions and etc. Please read through this manual clearly before usage. Also, this manual must be delivered to the final user and it has to be placed where users can refer to it at anytime.

- * Information contained in this manual can be changed for improvement without prior notification.
- * If you have any question or find any error from this manual, please contact our company or business office.
- * It is prohibited to copy the information contained in this manual without notifying us.

■ Service (A/S)

- * When users want to get the A/S, please send the product to the nearest agency or to our head quarter.
- * When users want to bring the product to the company and get the A/S, please contact the person in charge and make the appointment.
- * Before users make the A/S appointment, please refer to the FAQ on our homepage first. Your questions are maybe answered in our FAQ.

Hanyoung NUX

1381-3, Juan-Dong, Nam-Gu, Incheon, Korea

TEL : (+82-32) 876-4697

FAX : (+82-32) 876-4696

URL : <http://www.hynux.com>

E-mail : overseas@hynux.com

1.1 Safety information

Please read safety information carefully before use and then use this product properly. Safety information described in this manual contains important contents related with safety. So please follow the instructions accordingly. Safety information is composed of DANGER, WARNING and CAUTION.

Danger

Do not touch or contact the input/output terminals because it may cause electric shock.

Warning

- If there is a possibility of an accident caused by errors or malfunctions of this product, install external protection circuit to prevent the accident.
- This product does not contain an electric switch or fuse, so the user needs to install a separate electric switch or fuse externally.
(Fuse rating : 250 V 0.5A)
- To prevent deflection or malfunction of this product, supply proper power voltage in accordance with the rating.
- To prevent electric shock or device malfunction of this product, do not supply the power until the wiring is completed.
- Since this product is not designed with explosion-protective structure, do not use it at any place with flammable or explosive gas.
- Do not decompose, modify, revise or repair this product. This may cause malfunction, electric shock or fire.
- Reassemble this product while the power is off. Otherwise, it may cause malfunction or electric shock.
- If you use the product with methods other than specified by the manufacturer, there may be bodily injuries or property damages.
- Due to the danger of electric shock, use this product installed onto a panel while an electric current is applied.
- Do not heat or incinerate this product because it has a built-in lithium battery.
Otherwise it may cause explosion or fire.

Caution

- The contents of this manual maybe changed without prior notification.
- Before using the product you have purchased, check to make sure that it is exactly what you ordered.
- Check to make sure that there is no damage or abnormality of the product during delivery.
- Do not use this product at any place with corrosive (especially noxious gas or ammonia) or flammable gas.

- Do not use this product at any place with direct vibration or impact.
- Do not use this product at any place with liquid, oil, medical substances, dust, salt or iron contents. (Use at Pollution level 1 or 2)
- Do not polish this product with substances such as alcohol or benzene.
- Do not use this product at any place with excessive induction trouble, static electricity or magnetic noise.
- Do not use this product at any place with possible thermal accumulation due to direct sunlight or heat radiation.
- Install this product at place under 2,000 m in altitude.
- When the product gets wet, the inspection is essential because there is danger of an electric leakage or fire.
- If there is excessive noise from the power supply, using insulating transformer and noise filter is recommended. The noise filter must be attached to a panel grounded, and the wire between the filter output side and power supply terminal must be as short as possible.
- It is effective to use a twisted cable for power supply against noise.
- Do not connect anything to the unused terminals.
- After checking polarity of terminal, connect wires at the correct position.
- When this product is connected to a panel, use a circuit breaker or switch approved with IEC947-1 or IEC947-3.
- Install the circuit breaker or switch at near place for convenient use.
- Write down on a label that the operation of circuit breaker or switch disconnects the power since the device is installed.
- For the continuous and safe use of this product, the periodical maintenance is recommended.
- Some parts of this product have limited life span, and others are changed by their usage.
- The warranty period for this product including parts is one year if this product is properly used.
- When the power is on, the preparation period of contact output is required. In case of use for signals of external interlock circuit, use with a delay relay.

2 Suffix code

Model	Information
LY4	LCD weekly/yearly time switch (DIN 48(W) × 48(H) mm)

3 Specification

Model		LY4
Power supply voltage		100 – 240 V a.c 50/60 Hz(dual usage)
Allowable voltage variation		±10 % of the power supply voltage
Power consumption		Approx 2.6 VA (220 V a.c 60 Hz)
Display method		LCD display method (displayable digit : 4 digits, 2 lines) – 1st display : character height 7.8 mm – 2nd display : character height 5.2 mm
1 cycle time		Weekly setting : for 1 week (7days), Yearly setting : for 1 year (calendar until 2099)
Backup time		More than 5 consecutive years (25°C)
setting steps	Number of program setting	Weekly program : 64 step, yearly program : 32 step
	Number of season setting	4 seasons (Spring, summer, fall, winter)
	Number of holidays in one year	16 times
Installation type(external connection)		Flush panel mount type, and exposed panel mount type(dual usage) (Din rail installation and screw fixing)
Cycle error		±15sec/mon(25°C)
Time error		Less than ±0.01 % ±0.05 sec (Setting error, Power error, Temperature error)
Control output	Contact composition	OUT : SPST (1a)
	Contact capacity	15 A 250 V a.c (resistive load)
Relay life expectancy	Life Expectancy(mechanically)	Above 10 million times
	Life Expectancy(electrically)	Above 50 thousand times (250 V a.c 15 A resistive load)
Insulation resistance		100 MΩ min (500 V d.c mega standard, actuator terminal and exposed non-charge dm etal part)
Dielectric strength		2000 V a.c 50/60 Hz for 1 min (actuator terminal and exposed non-charged metal part)
Noise immunity		±2 kV (between the actuating power terminal), square wave shape noise by the noise simulator (Pulse width = 1 us).
Vibration	Vibration resistance	10 – 55 Hz (for cycle 1 min) 0.75 mm double amplitude for 1 hrs each in X, Y and Z
	Malfunction	10 – 55 Hz (for cycle 1 min) 0.5 mm double amplitude for 10 minutes each in X, Y and Z
Storage	Shock resistance	300 %s 3 times each in X, Y and Z directions
	Malfunction	100 %s 3 times each in X, Y and Z directions
Ambient temperature		-10 ~ 55 °C (with no icing)
Storage temperature		-20 ~ 65 °C (with no icing)
Ambient humidity		35 ~ 85 % RH
Weight		Approx. 100 g (excluded the weight of box)

※ Customer can not exchange parts(including battery).

4 Appearance and panel cutout dimension

(Unit : mm)

4.1 Flush panel type

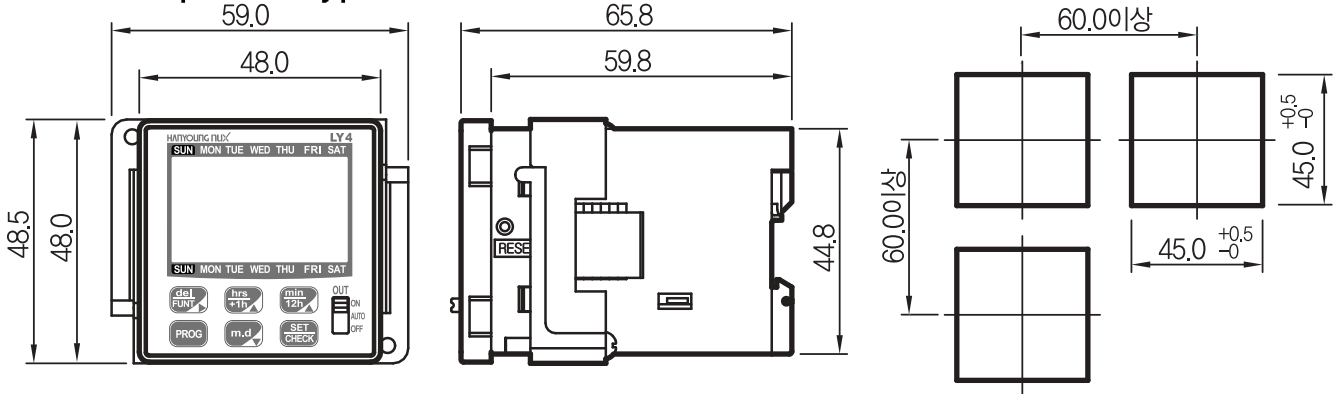

4.2 Exposed type

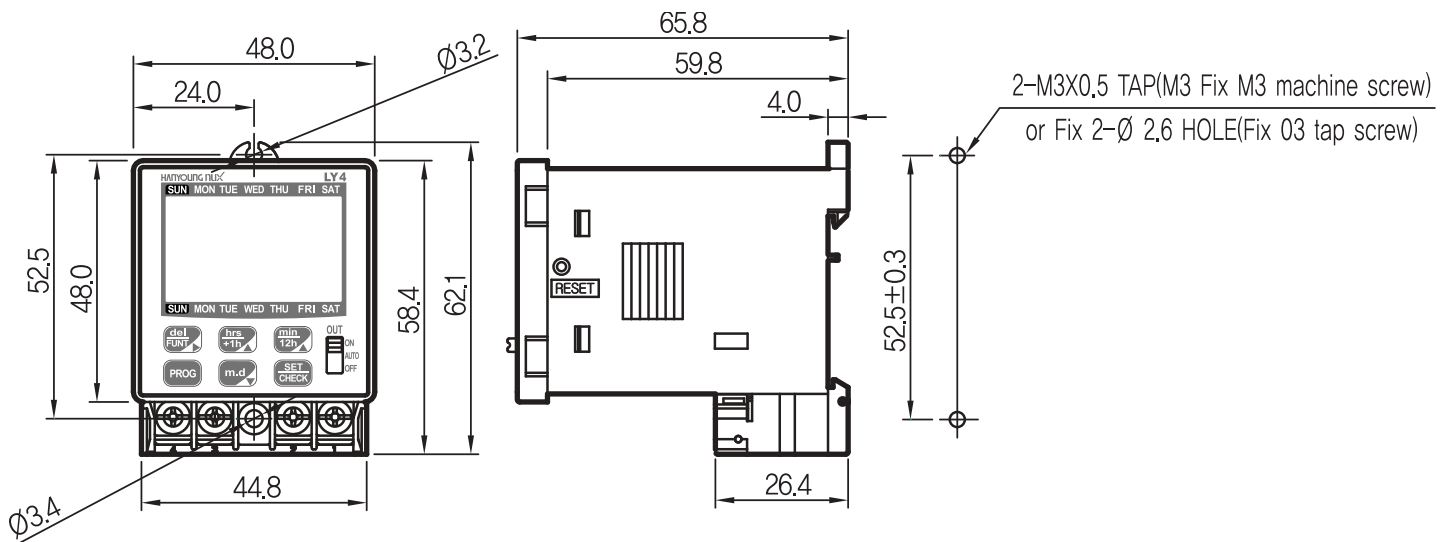

4.3 DIN rail mounting type

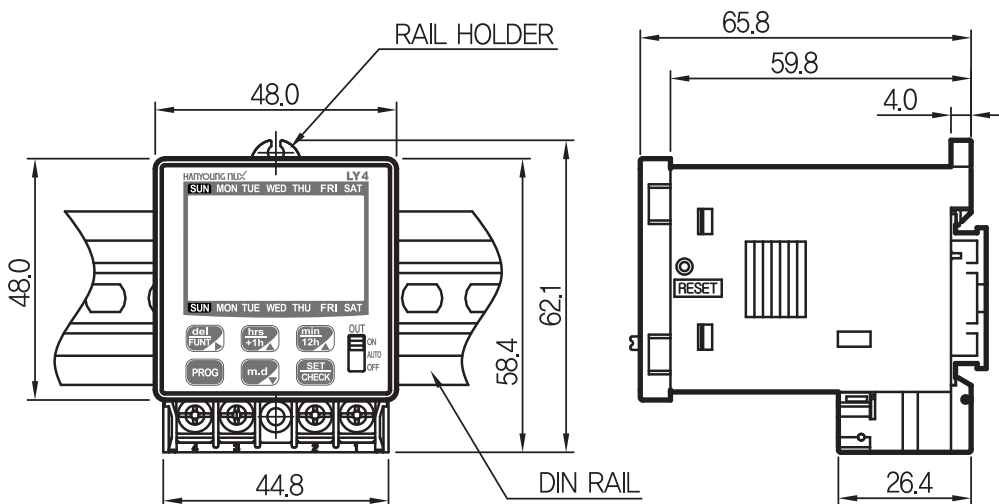

5 Connection diagram

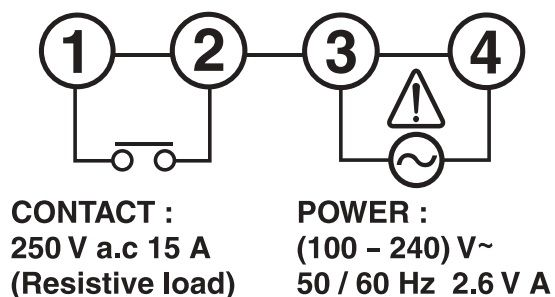

6 Output connection

6.1 LY4 In case when power and load power are different

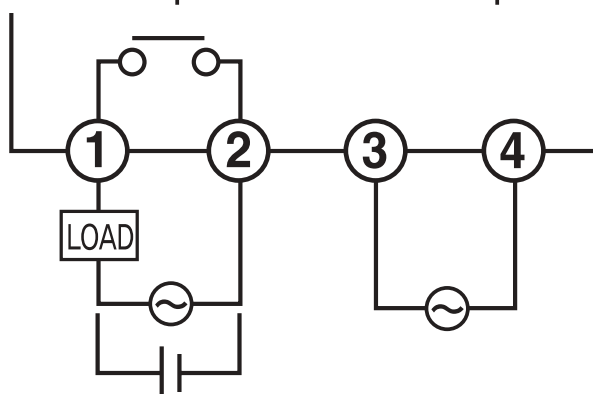

6.2 LY4 In case when power and load power are same

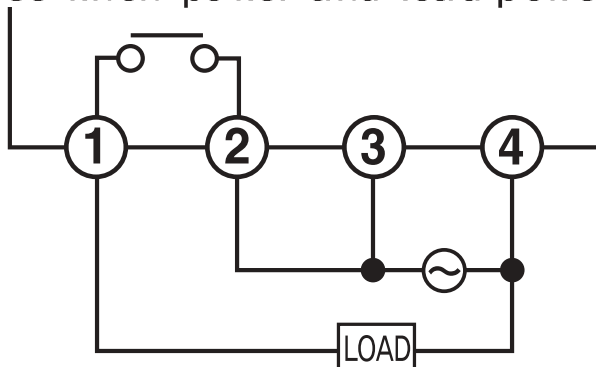

7 Front panel composition

7.1 LCD display

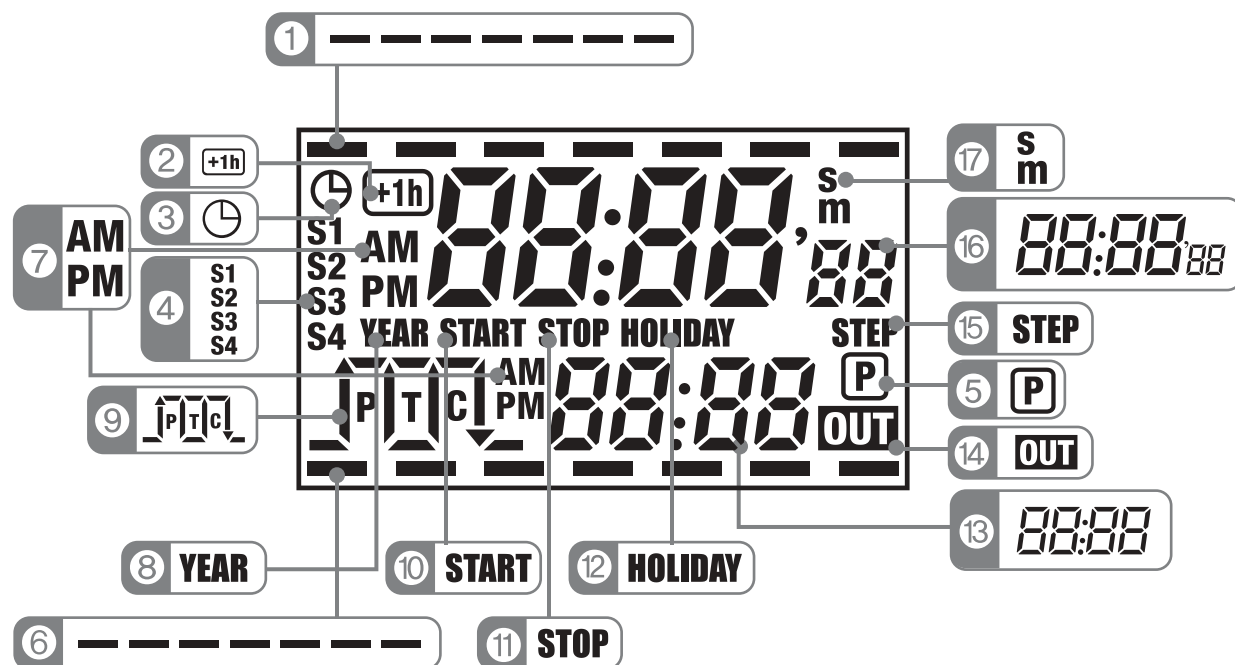

Lists	Information
① Day indicator	Current day indication and setting day cursor
② Summer time indication	Indicated in the summer time
③ Time adjustment indicator	Indicated when setting the current time
④ Season indication	Indicates the season
⑤ Setting port number indication	Indicates the port number that has been set
⑥ Set day indicator	Indicates the set day
⑦ AM/PM indicator	Indicates AM/PM 12h
⑧ Yearly indicator	Indicates the yearly program setting status
⑨ Operation state indicator	Indicates the timer, pulse, cycle ad onsetting and indicates the next action state operation ※ Timer action : Start time : End time : ※ Pulse action : Pulse time width : ※ Cycle action : Start time : End time :
⑩ Start date indicator	Indicated when setting the yearly start date
⑪ End date indicator	Indicated when setting the yearly end date
⑫ Holiday indicator	Indicated on the holiday or indicated when setting the holiday

⑬ Sub display	Indicates current month, date and next operation time
⑭ Output action indicator	Indicates the output number where output operation is set as ON
⑮ Remaining step indicator	Display the number of remaining steps
⑯ Main display	Indicates current time and indicated when setting the program
⑰ Pulse width unit indicator	Indicates the pulse range time unit within the pulse operation

7.2 Front panel

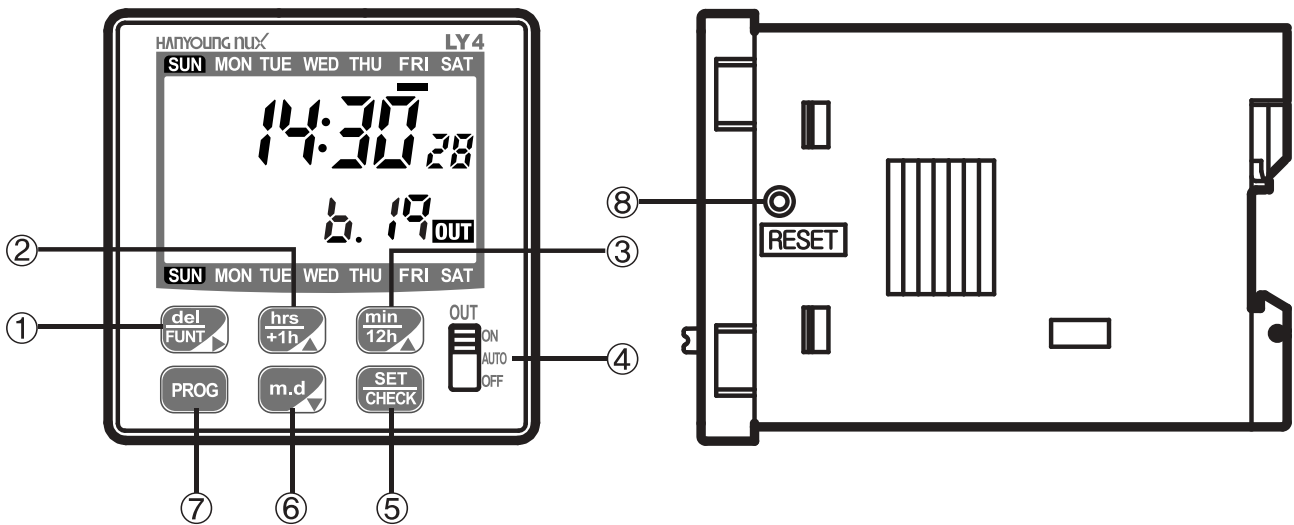

Lists	Information
① FUNT (Function key)	FUNT : applied when setting the function (time setting, holiday setting, season setting, summer time setting, power backup setting) del : applied as the program delete key in the weekly/yearly program setting edit mode. Or used as UP key when setting the [year] (with year setting) SHIFT : applied as the shift key when setting the weekly program operation date setting.
② +1h key	+1h : used when applying the summer time manually (operation mode) hrs : Use UP key to set [hour]. Also, use UP key to set [month](with year setting)
③ 12/24h key	12/24h : applied as the time changing key (operation mode) - Display the current time as 24h and convert to the AM/PM 12h. min : Use UP key to set [min]. also, user UP key to set [day](with year setting)
④ Output setting switch	ON : Forcedly turn ON the output disregarding the program setting information. AUTO : Output operated depending on the program setting information. OFF : Forcedly turn OFF the output operation disregarding the program setting information.

⑤ SET/CHECK key	SET : Used as SET key in the setting mode CHECK : Used as the weekly/yearly program check key in the operation mode.
⑥ m.d key	m.d : applied as the key to change the 2nd display [current date display (month, day) to the [next operation time display] (operation mode state) DOWN : apply as the DOWN KEY regarding the previous time value.
⑦ PROG (program key)	Applied when setting the program (weekly/yearly program setting and editing, deleting, inspecting)
⑧ RESET key	Reset (initialize) all settings including the current time.

8 Panel type/exposed type converting method

- Unloosen the terminal tightening bolt from the case, hold the case/terminal and pull them in the direction of up and down just like an image provided in the below then it will be converted to the exposed type.
- In order to fix the terminal, please retighten the fixing bolt, switch left/right side terminal bolt and then tighten them.
- When switching the type from exposed type to the Panel type, please follow the image provided in the below but only in a reverse order

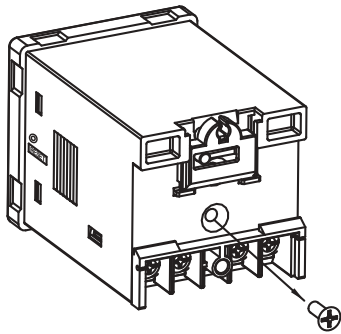

1. Unloosen the terminal fixing bolt (panel flush type)

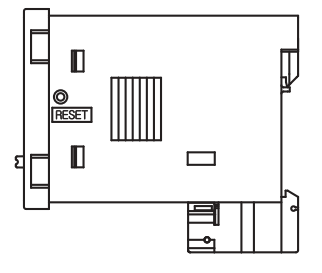

2. Remove the terminal block

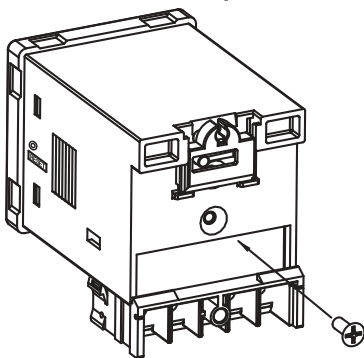

3. Retighten the terminal fixing bolt.

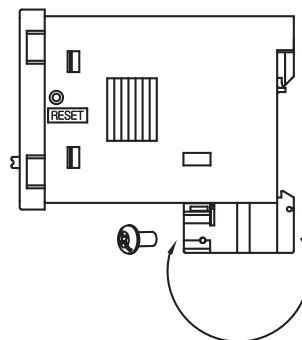

4. Switch left/right side terminal bolt and tighten them.

Push up by pressing the HOLDER

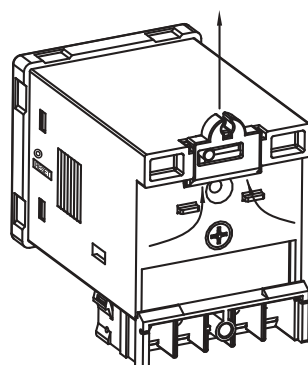

5. Exposed type

9 Function explanation

9.1 Operation function explanation

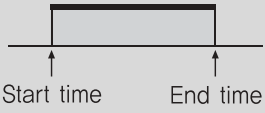
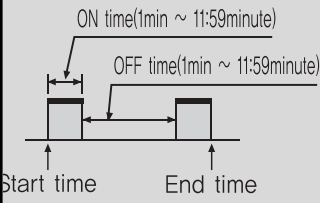
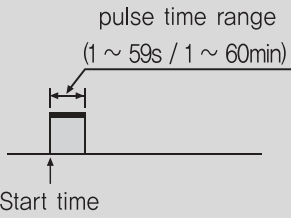
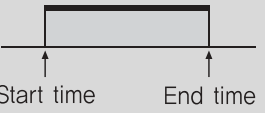
Lists	Information
<p>Weekly timer operation</p> 	<p>Control the output depending on the set start / end time. (After setting the weekly timer operation and when setting the additional program, users will not be able to use the pulse operation setting.)</p> <ul style="list-style-type: none"> • minimum setting time unit: 1 min. • weekly timer operation setting is composed of 2 STEP. <ul style="list-style-type: none"> - start day / start time (1 STEP) - end day / end time (1 STEP)
<p>Weekly cycle operation</p> 	<p>It repeats the ON/OFF operation with the range of ON time and OFF time within the time from start set time to the end set time. (After setting the cycle operation and when setting the additional setting, users will not be able to use the weekly pulse operation setting.)</p> <ul style="list-style-type: none"> • minimum set time unit : 1 min. • ON time range, OFF time range : 00:01 ~ 11:59 • Weekly cycle operation setting is composed of 4 STEP. <ul style="list-style-type: none"> - Start day / end time (1 STEP) - End day / end time (1 STEP) - ON time range (1 STEP) - OFF time range (1 STEP)
<p>Weekly pulse operation</p> 	<p>Operate the output as an ON operation which starts from the start set time until it reaches a certain period of time. (After setting the weekly pulse operation and when setting the additional setting, users will not be able to use the weekly timer operation setting and weekly cycle operation setting)</p> <ul style="list-style-type: none"> • pulse time range : 1 ~ 59 s (1 sec unit), 1 ~ 60 min (1 min unit) • weekly pulse operation setting is composed of 2 STEP. <ul style="list-style-type: none"> - start day/start time (1 STEP) - pulse time range (1 STEP)
<p>Yearly timer operation</p> 	<p>It controls the output depending on the start/end time which had been set in between the start time and the end time (Possible to set the operation every year)</p> <ul style="list-style-type: none"> • Able to add the yearly timer operation to the weekly timer operation. • Minimum set time unit : 1min. • Yearly timer operation is composed of 4 STEP. <ul style="list-style-type: none"> - Start day (1 STEP) - End day (1 STEP) - Start time (1 STEP) - End time (1 STEP)

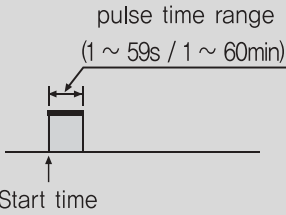
<p>Yearly pulse operation</p> 	<p>Operate the output as an ON operation at the start time that had been set in between of start time and end time. (Operation setting function yearly)</p> <ul style="list-style-type: none"> • Able to add the yearly pulse operation to the weekly pulse operation. • - Pulse range : 1 ~ 59 s (1sec unit), 1 ~ 60 min (1min unit) - 1sec → 2sec • • • 59sec → 1min → 2min • • • 59min → 60min → 1sec • • • • Yearly timer operation is composed of 4 STEP. <ul style="list-style-type: none"> - Start day (1 STEP) - End day (1 STEP) - Start time (1 STEP) - Pulse time range (1 STEP)
<p>Current time setting</p>	<p>Applied when setting the current time</p> <ul style="list-style-type: none"> • When using this for the first time or after resetting the program, screen will become time adjusting screen so please use it after setting the current time.
<p>Holiday setting</p>	<p>By setting the date for weekend, national holiday and etc, users temporarily can set holiday (Non-operation day) without editing the program.</p> <ul style="list-style-type: none"> • When changing the season setting, all of the weekly programs will be deleted.
<p>Season setting</p>	<p>By setting terms for the season, users can set the weekly operation program to become changed automatically when season changes.</p> <ul style="list-style-type: none"> • Possible to set the holiday every year • Use it same as the yearly operation setting.
<p>Summer time switch</p>	<p>Summer time setting can be set automatically and manually .</p> <ul style="list-style-type: none"> • current time ⇔ switch to current time + 1h (summer time)
<p>Program check</p>	<p>Applied when needs to check the program setting information in the operation mode state.</p> <ul style="list-style-type: none"> • operated depending on the program setting information and output does not get blocked • displayed in the order of program input • if there are no key input for 1 min then it will return to the operation mode automatically
<p>Program edit</p>	<p>Able to edit and delete the program setting</p> <ul style="list-style-type: none"> • unable to revise the setting for tire operation, pulse operation and cycle operation. • displayed in the order of program input.
<p>Program test</p>	<p>Check the day for actual output to start and end for 1 week.</p> <ul style="list-style-type: none"> • within the same output program, if program and operation time are duplicated then it may be ignored. • It continuously displays from the output 1 until the date reaches 1 week in the consecutive operation time order.

9.2 Operation explanation

- Operation 1 : when inputting the additional weekly program ② to the weekly set program ①, output will be operated just like an operation 1.
- Operation 2 : when inputting the additional yearly program ② to the yearly set program ①, output will be operated just like an operation 2.
- Operation 3 : when inputting the additional yearly program ① to the weekly set program ①, output will be operated just like an operation 3.
- Operation 4 : when inputting the additional weekly program ② to the yearly set program ②, output will be operated just like an operation 4.

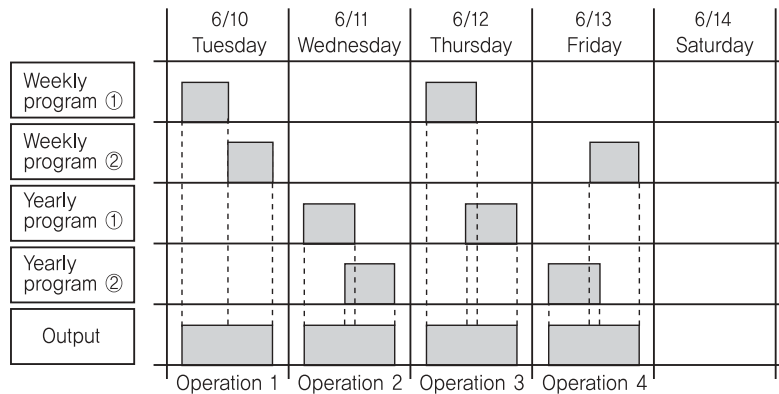

10 Parameter formation

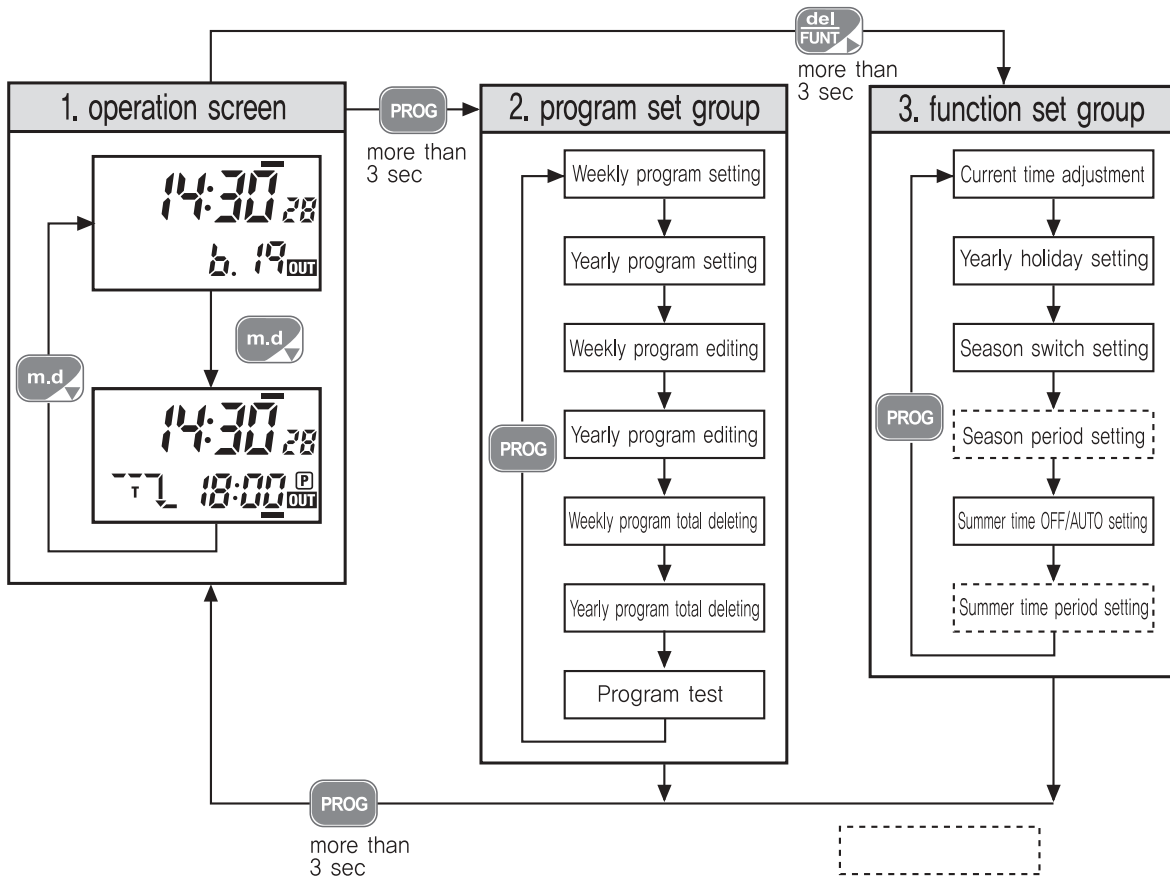

- ※ It will be only displayed in case Season switch setting is "ON".
- ※ It will be only displayed in case of Summer time "AUTO".

※ What is operation screen?

Supplying in the power will display the certain time. This screen is known as operation screen.
(When reset the program, please set the current time and use it)

※ Return to the operation screen

Pressing the **PROG** key for more than 3 sec within the program setting mode or function setting mode will return to the operation screen mode.

※ Movement between each of parameters

1) How to enter into the program setting group

Press the PROG key for 3 sec in the operation screen (time display) state.

2) How to enter into the function setting group

Press the FUNT key for 3 sec in the operation screen (time display) state.

3) How to return to the operation state from the setting group

Pressing the PROG key for 3 sec within the function setting group and program setting group will return to the operation state.

4) Movement between each mode of setting group

Pressing the PROG key shortly will display the setting mode sequentially

5) Screen switch

Pressing the [decrement (m)] key for 1 sec within operation screen (time display) will change the operation screen display.

6) Manually change the summer time

Pressing the [incremental (+h)] key for 1 sec within operation screen (time display) will display +1h and current time will become 1 hour faster. (Repeating this one more time will return to the current time)





7) 12/24h indication selectable

Every time when you press the incremental (12/24h) key for 1 sec within operation screen (time display), it will be switched from 24 to AM/PM12 and from AM/PM12 to 24

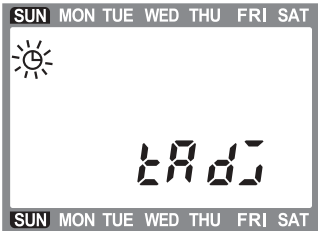
11 Time adjusting method

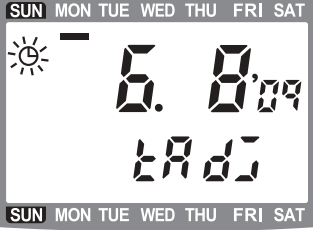
(Setting example) set the current time as 2009 6/8 13:40

Parameter	Explanation
<p>①</p> 	<p>① Enter into the current time set mode</p> <ul style="list-style-type: none"> • Pressing the FUNT key for more than 3 sec within the operation mode will enter into the "time set mode." (☉ flickers) • Press the SET key











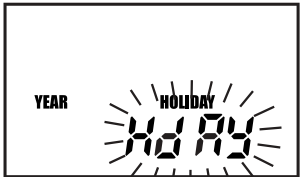

<p>②</p> 	<p>② Set current year, month, day</p> <ul style="list-style-type: none"> • Set year, month and day by pressing the del, hrs and min key but  key is applied when decreasing the previous value. • Once setting the current year, month and day are completed, press the SET key.
<p>③</p> 	<p>③ Set current time</p> <ul style="list-style-type: none"> • Set hour and min by pressing the hrs and min key but  key is applied when decreasing the previous time. • Once setting the current time is completed, press the SET key.
<p>④</p> 	<p>④ Return to the operation mode</p> <ul style="list-style-type: none"> • Since setting has been completed, pressing the PROG key for more than 3 sec will confirm the setting and return to the operation mode. • When revising the setting, please repeat the given steps (①~④)
<ul style="list-style-type: none"> • When running the program for the first time or after resetting the program, it will display the time adjusting screen so please set the current time by following steps ② and ③. • Pressing the UP and DOWN key for more than 1 sec will change the setting instantly. • Allowable range of current time setting is maximum 2099 12/31. 	

12 Setting group formation

12.1 Program set group formation

Parameter	Explanation
	<p>Operation mode</p> <ul style="list-style-type: none"> • Display current time and day
	<p>Weekly program set mode</p> <ul style="list-style-type: none"> • “YE EX” Flickers • Display weekly remaining STEP
	<p>Yearly program set mode</p> <ul style="list-style-type: none"> • “YE AR” Flickers • Display yearly remaining STEP
	<p>Weekly program revise and delete mode</p> <ul style="list-style-type: none"> • “YE EX” Flickers • Display weekly total STEP
	<p>Yearly program revise and delete mode</p> <ul style="list-style-type: none"> • “YE AR” Flickers • Display yearly total STEP
	<p>Weekly program total delete mode</p> <ul style="list-style-type: none"> • “YE EX” Flickers • Weekly program total delete
	<p>Yearly program total delete mode</p> <ul style="list-style-type: none"> • “YE AR” Flickers • Yearly program total delete
	<p>Program test mode</p> <ul style="list-style-type: none"> • “TEST” Flickers • Display 1 week and 1 minute continuously in the operation time order

12.2 Function set group formation











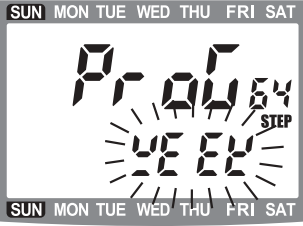
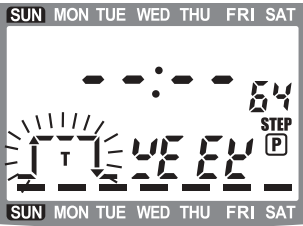

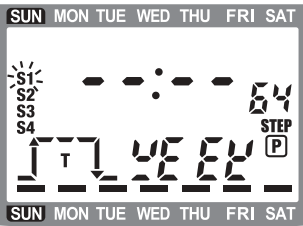
Parameter	Explanation
	Operation mode <ul style="list-style-type: none"> • Display current time and day
	
	Time adjustment setting <ul style="list-style-type: none"> • “☉” Flickers • Set current year/month/day 「00 year, 00 month, 00 day」 • Set current time 「00 hour, 00 min」
	
	Holiday setting <ul style="list-style-type: none"> • “HOLIDAY” Flickers • Used when setting the holiday (non-operating day) • Number of holiday setting : 16 times • Set the start year/month/day • Set the end year/month/day • Possible to set every year
	
	Season selection <ul style="list-style-type: none"> • “SE 5n” Flickers • Set seasons by considering the weekly program (Cautious) when changing the season, settings in the weekly program will be deleted.
	
	Set the period for season switching <ul style="list-style-type: none"> • Displayed when setting the SE 5n mode as ON • Select the season that you want to set a period on • Number of season setting : 4 seasons(S1, S2, S3, S4) • Set the start month/day • Set the end month/day
	
	Summer time switching automatically <ul style="list-style-type: none"> • “d 5t” Flickers • Current time ⇔ current time +1h (summer time) • AUTO : Summer time auto switching (change depending on the setting period) • OFF : Summer time manual switching (change depending on the +h key)
	
	Summer time “AUTO” operation setting <ul style="list-style-type: none"> • Displayed when setting the “d 5t” mode as AUTO • Summer time auto switching period setting <ul style="list-style-type: none"> – Set the start month/day/hour – Set the end month/day/hour

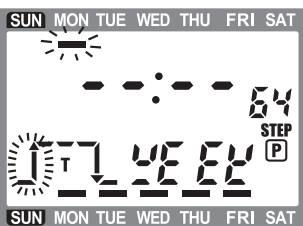

13 Program setting (program set group)

13.1 Normal timer operation

Example) Output 1 operates as ON from Monday to Friday at 8:30 to 17:40 Parameter

Sunday	Monday	Tuesday	Wednesday	Thursday	Friday	Saturday
	8:30 ~ 17:40	8:30 ~ 17:40	8:30 ~ 17:40	8:30 ~ 17:40	8:30 ~ 17:40	

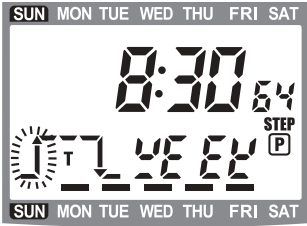
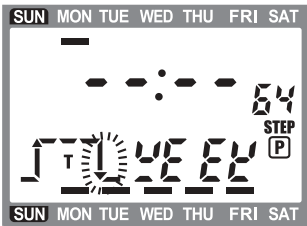
Parameter	Explanation
<p>①</p> 	<p>① Enter into the weekly program setting</p> <ul style="list-style-type: none"> Press the PROG key within the operation mode state then 8:30 will flicker. Once flickers, please press the SET key
<p>②</p> 	<p>② Operation mode setting</p> <ul style="list-style-type: none"> Since it is in the timer operation mode, press the SET key right away <p>(when changing the operation setting, press the  or  key)</p>
<p>③</p> 	<p>③ Season setting</p> <ul style="list-style-type: none"> When setting the season, press  or  key to set. Once "S1" starts to flicker, press the SET key. But only able to set when season switching is set as ON. If season switching is not set as ON, it will go to the day setting mode.
<p>④</p> 	<p>④ Start day setting</p> <ul style="list-style-type: none"> Because the position of cursor () is on sunday (SUN), turn the cursor () OFF which positioned on the setting day by pressing the  and  key. Shift the position of cursor to the saturday (SAT) by pressing the  key and turn the cursor () OFF which positioned on the setting day by pressing the  and  key Once the start time setting is completed, press the SET key.

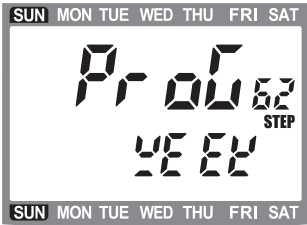

	<p>⑤ Start time setting</p> <ul style="list-style-type: none"> • Set the start time by using the hrs and min key but \blacktriangledown key is only used when decreasing the previous value. • Once the start time setting is completed, press the SET key.
	<p>⑥ End day setting</p> <ul style="list-style-type: none"> • End day is same as the start day so press the SET key. (Follow the start day setting ④)
	<p>⑦ End time setting</p> <ul style="list-style-type: none"> • Set the end time by using the hrs and min key but \blacktriangledown key is only used when decreasing the previous value. • Once the end time setting is completed, press the SET key
	<p>⑧ Return the weekly program setting</p> <ul style="list-style-type: none"> • Press the PROG key for more than 3 sec in order to return to the operation mode.
<ul style="list-style-type: none"> • Pressing the UP, DOWN key for more than 1 sec will change the time value instantly. • When adding additional programs to the set program, please repeat steps from ② to ⑧ • Weekly timer setting is composed of 2 STEP and once setting is completed then it will display number of remaining STEP that can be set 	

13.2 Days timer operation

Example) Output ON operation from Mon 8:30 to Fri 17:40

Sunday	Monday	Tuesday	Wednesday	Thursday	Friday	Saturday
	8:30				17:40	

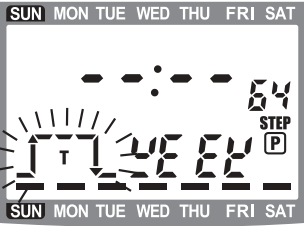
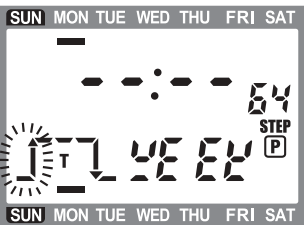
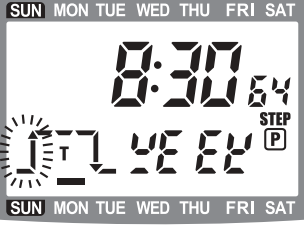
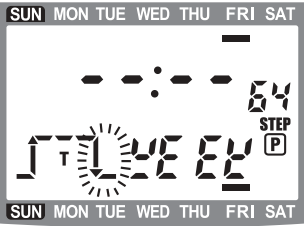

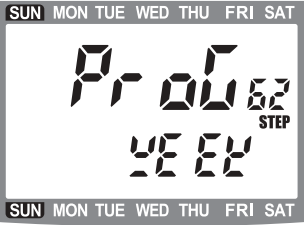
Parameter	Explanation
	<p>① Enter into the weekly program setting</p> <ul style="list-style-type: none"> • Pressing the PROG key for more than 3 sec within the operation mode will flicker the “WEEK”. Here, press the SET key.



<p>②</p> 	<p>② Operation mode setting</p> <ul style="list-style-type: none"> • Since it is in the timer operation mode, press the SET key right away <p>(When changing the operation setting, press the ▲ or ▼ key)</p>
<p>③</p> 	<p>③ Start day setting</p> <ul style="list-style-type: none"> • Because the position of cursor (—) is on the Sunday (SUN), turn OFF — that is on the set day position by pressing the ▼ or ▲ key. • Shift the position of cursor to the Saturday (SAT) by using ► key and turn OFF • Once the start day setting is completed, press the SET key.
<p>④</p> 	<p>④ Start time setting</p> <ul style="list-style-type: none"> • Set the start time by using the hrs and min key but ▼ key is only used when decreasing the previous value. • Once the start time setting is completed, press the SET key.
<p>⑤</p> 	<p>⑤ End day setting</p> <ul style="list-style-type: none"> • Shift the position of cursor (—) to the Monday (MON) by using ► key and turn OFF — that is on the set day position by pressing ▲ or ▼ key. • Shift the position of cursor to the Friday (FRI) and turn OFF — • Once the end day setting is completed, press the SET key.
<p>⑥</p> 	<p>⑥ End time setting</p> <ul style="list-style-type: none"> • Set the end time by using the hrs and min key but ▼ key is only used when decreasing the previous value. • Once the end time setting is completed, press the SET key
<p>⑦</p> 	<p>⑦ Return the weekly program setting</p> <ul style="list-style-type: none"> • Press the PROG key for more than 3 sec in order to return to the operation mode.
<ul style="list-style-type: none"> • Pressing the UP, DOWN key for more than 1 sec will change the setting instantly. • When adding additional programs to the set program, please repeat steps from ② to ⑦. <p>Caution) Please do not overlap operation time with other programs' one, when setting to add program within the same output port</p>	

13.3 Next day timer operation

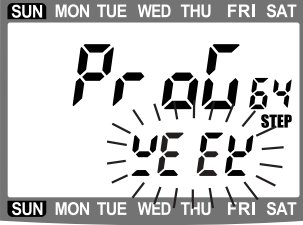
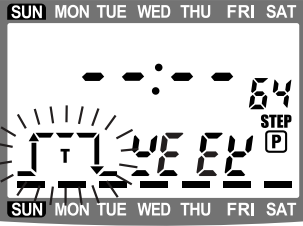
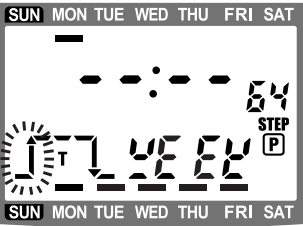
Example) Output ON operation from Mon ~ Fri 20:30 to the next day 6:30

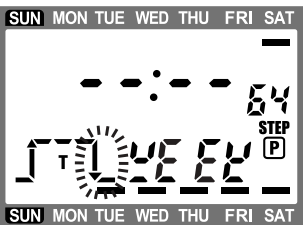
Sunday	Monday	Tuesday	Wednesday	Thursday	Friday	Saturday
	20:30 6:30	20:30 6:30	20:30 6:30	20:30 6:30	20:30 6:30	20:30 6:30

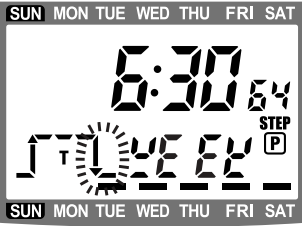
Parameter	Explanation
<p>①</p> 	<p>① Enter into the weekly program setting</p> <ul style="list-style-type: none"> Pressing the PROG key for more than 3 sec within the operation mode will flicker the "4E E4". Here, press the SET key.
<p>②</p> 	<p>② Operation mode setting</p> <ul style="list-style-type: none"> Since it is in the timer operation mode, press the SET key right away (when changing the operation setting, press the \blacktriangle or \blacktriangledown key)
<p>③</p> 	<p>③ Start day setting</p> <ul style="list-style-type: none"> Because the position of cursor (\blacksquare) is on sunday (SUN), turn the cursor (\blacksquare) OFF which positioned on the setting day by pressing the \blacktriangledown and \blacktriangle key. Shift the position of cursor to the saturday (SAT) by pressing the \blacktriangleright key and turn the cursor (\blacksquare) OFF which positioned on the setting day by pressing the \blacktriangle and \blacktriangledown key Once the start day setting is completed, press the SET key.
<p>④</p> 	<p>④ Start time setting</p> <ul style="list-style-type: none"> Set the start time by using the hrs and min key but \blacktriangledown key is only used when decreasing the previous value. Once the start time setting is completed, press the SET key.
<p>⑤</p> 	<p>⑤ End day setting</p> <ul style="list-style-type: none"> Shift the position of cursor (\blacksquare) to the Monday (MON) by using \blacktriangleright key and turn OFF \blacksquare that is on the set day position by pressing \blacktriangle or \blacktriangledown key. Shift the position of cursor to the Saturday (SAT) and turn OFF \blacksquare Once the end day setting is completed, press the SET key.



<p>⑥</p> 	<p>⑥ End time setting</p> <ul style="list-style-type: none"> • Set the end time by using the hrs and min key but \blacktriangledown key is only used when decreasing the previous value. • Once the end time setting is completed, press the SET key
<p>⑦</p> 	<p>⑦ Return the weekly program setting</p> <ul style="list-style-type: none"> • Press the PROG key for more than 3 sec in order to return to the operation mode.
<ul style="list-style-type: none"> • Pressing the UP, DOWN key for more than 1 sec will change the setting instantly. • When adding additional programs to the set program, please repeat steps from ② to ⑦. 	

13.4 Weekly pulse operation

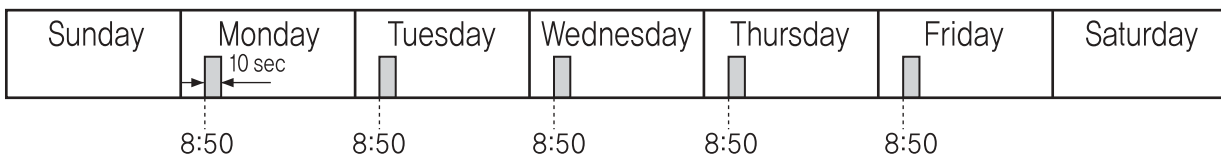
Example) Output ON operation from Monday to Friday at 8:50 for only 10 sec

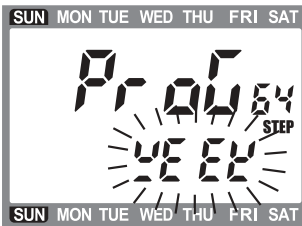
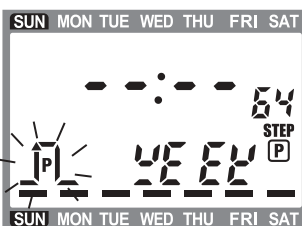
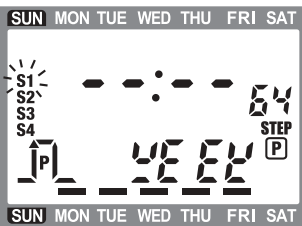

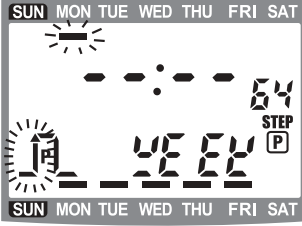
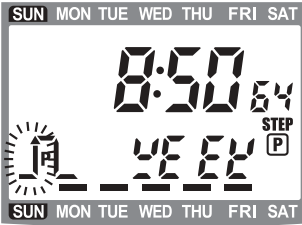
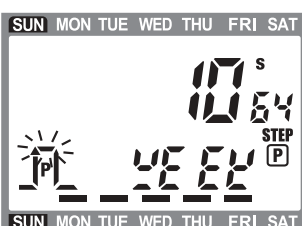
Parameter	Explanation
<p>①</p> 	<p>① Enter into the weekly program setting</p> <ul style="list-style-type: none"> • Pressing the PROG key for more than 3 sec within the operation mode will flicker the “YE EX”. Here, press the SET key.
<p>②</p> 	<p>② Operation mode setting</p> <ul style="list-style-type: none"> • Since it is in the timer operation mode, press \blacktriangle or \blacktriangledown key to set the pulse operation mode • Once pulse operation setting is completed, press the SET key.
<p>③</p> 	<p>③ Season setting</p> <ul style="list-style-type: none"> • When setting the season, press \blacktriangle or \blacktriangledown key to set it • Once S1 starts to flicker, press the SET key. But, able to set when season switching is set as ON. If season switching is not set as ON, it will go to the day setting.









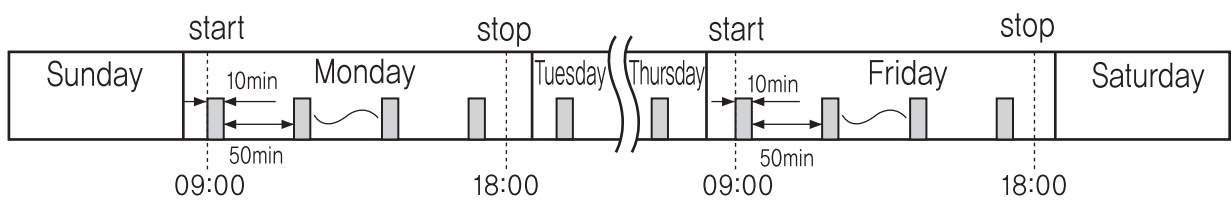

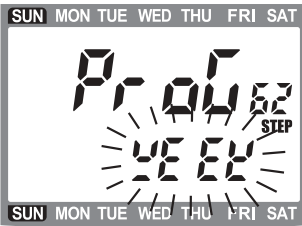
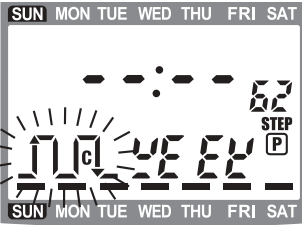

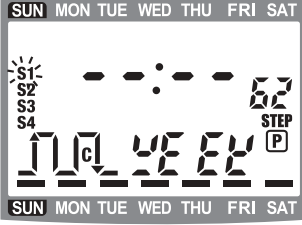
<p>④</p> 	<p>④ Start day setting</p> <ul style="list-style-type: none"> • Because the position of cursor(—) is on the Sunday (SUN), turn OFF that is on the set day position by pressing the ▼ or ▲ key. • Shift the position of cursor to the saturday (SAT) by pressing the ► key and turn the cursor (—) OFF which positioned on the setting day by pressing the ▲ and ▼ key • Once the start day setting is completed, press the SET key.
<p>⑤</p> 	<p>⑤ Start time setting</p> <ul style="list-style-type: none"> • Set the start time by using the hrs and min key but ▼ key is only used when decreasing the previous value. • Once the start time setting is completed, press the SET key.
<p>⑥</p> 	<p>⑥ Pulse time range setting</p> <ul style="list-style-type: none"> • Set the pulse time range by using the min key, but ▼ key is only used when decreasing the previous value. • Once pulse time range setting is completed, press the SET key.
<p>⑦</p> 	<p>⑦ Return the weekly program setting</p> <ul style="list-style-type: none"> • Press the PROG key for more than 3 sec in order to return to the operation mode.

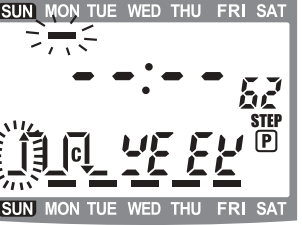

- Pressing the UP, DOWN key for more than 1 sec will change the setting instantly.
- When adding additional programs to the set program, please repeat steps from ② to ⑦.
- Caution) If the weekly pulse operation is set within the same output port, it cannot use the weekly timer and weekly cycle operation setting when setting the additional program
- Pulse time range: 1 ~ 59 s (1 sec unit), 1 ~ 60 min (1 min unit)
1s → 2s → ... → 59s → 1m → ... → 59m → 60m → 1s → ...
- Weekly pulse setting is composed of 2 STEP and once setting is completed then it will display number of remaining STEP that can be set

13.5 Weekly cycle operation

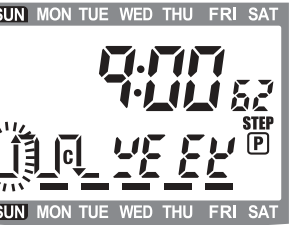
Example) From Monday to Friday at 9:00 to 18:00, it repeats following operation. Output ON for 10 min and output OFF for 50 min

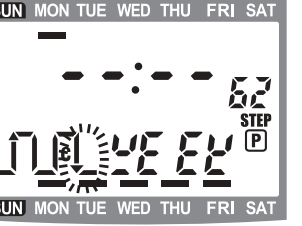

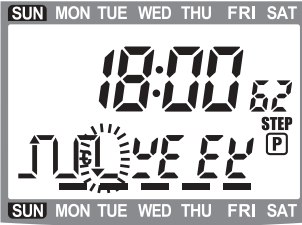
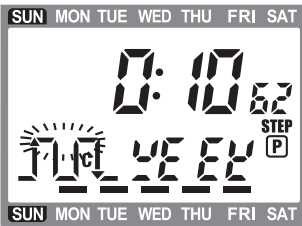
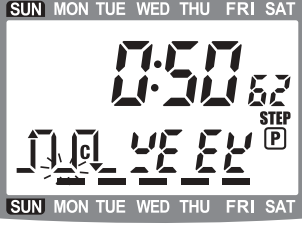
Parameter	Explanation
<p>①</p> 	<p>① Enter into the weekly program setting</p> <ul style="list-style-type: none"> Pressing the PROG key for more than 3 sec within the operation mode will flicker the “YEE”. Here, press the SET key.
<p>②</p> 	<p>② Operation mode setting</p> <ul style="list-style-type: none"> Since it is in the timer operation mode, press  or  key to set the cycle operation mode. Once cycle operation setting is completed, press the SET key.
<p>③</p> 	<p>③ Season setting</p> <ul style="list-style-type: none"> When setting the season, press  or  key to set it Once S1 starts to flicker, press the SET key. <p>But, able to set when season switching is set as ON. If season switching is not set as ON, it will go to the day setting.</p>
<p>④</p> 	<p>④ Start day setting</p> <ul style="list-style-type: none"> Because the position of cursor (—) is on sunday (SUN), turn the cursor (—) OFF which positioned on the setting day by pressing the  and  key. Shift the position of cursor to the saturday (SAT) by pressing the  key and turn the cursor (—) OFF which positioned on the setting day by pressing the  and  key Once the start day setting is completed, press the SET key.
<p>⑤</p> 	<p>⑤ Start time setting</p> <ul style="list-style-type: none"> Set the start time by using the hrs and min key but  key is only used when decreasing the previous value. Once the start time setting is completed, press the SET key.
<p>⑥</p> 	<p>⑥ End day setting</p> <ul style="list-style-type: none"> End day is same as the start day so press the SET key. Follow the start day setting ⑤







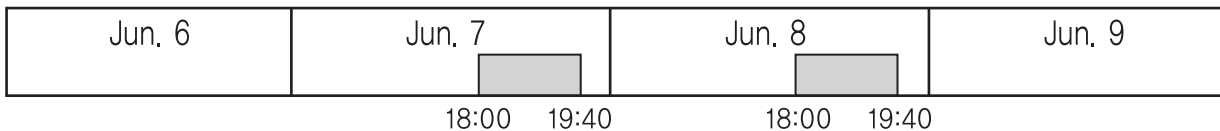

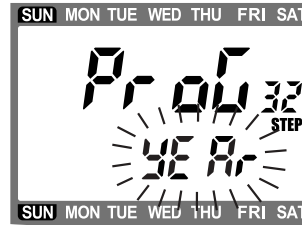

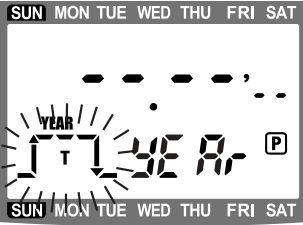

<p>⑦</p> 	<p>⑦ End time setting</p> <ul style="list-style-type: none"> • Set the end time by using the hrs and min key but ∇ key is only used when decreasing the previous value. • Once the end time setting is completed, press the SET key
<p>⑧</p> 	<p>⑧ ON time range setting</p> <ul style="list-style-type: none"> • Set the ON time range by using the hrs and min key but ∇ key is only used when decreasing previous value. • Once ON time range setting is completed, press the SET key.
<p>⑨</p> 	<p>⑨ OFF time range setting</p> <ul style="list-style-type: none"> • Set the OFF time range by using the hrs and min key but ∇ key is only used when decreasing previous value. • Once OFF time range setting is completed, press the SET key
<p>⑩</p> 	<p>⑩ Return the weekly program setting</p> <ul style="list-style-type: none"> • Press the PROG key for more than 3 sec in order to return to the operation mode.
<ul style="list-style-type: none"> • Pressing the UP, DOWN key for more than 1 sec will change the time value instantly. • When adding additional programs to the set program, please repeat steps from ② to ⑩ • Caution) if the weekly pulse operation is set within the same output port, it cannot use the weekly timer and weekly cycle operation setting when setting the additional program • Weekly pulse setting is composed of 4 STEP and once setting is completed then it will display the number of remaining STEP that can be set 	

13.6 Yearly timer operation

Example) From June 7 to June 8, Output on at 18:00 and out at 19:40 for every year



Parameter	Explanation
<p>①</p> 	<p>① Enter into the Yearly program setting</p> <ul style="list-style-type: none"> • Within the operation mode, press the PROG key for more than 3 sec to enter into the set mode and then press the PROG key one more time shortly then 4E Ar will start to flicker. Here, press the SET key.

<p>②</p> 	<p>② Operation mode setting</p> <ul style="list-style-type: none"> • Since it is in the timer operation mode, press the SET key right away <p>(when changing the operation setting, press the  or  key)</p>
<p>③</p> 	<p>③ Set the start year, month and day</p> <ul style="list-style-type: none"> • Set the end year, month and day by pressing the del, hrs and min key but  key is applied when decreasing the previous value. • Once setting the end year, month and day are completed, press the SET key <p>Cautious) within the year, the "--" indication is a setting for every year.</p>
<p>④</p> 	<p>④ Set the end year, month and day</p> <ul style="list-style-type: none"> • Set the end year, month and day by pressing the del, hrs and min key but  key is applied when decreasing the previous value. • Once setting the end year, month and day are completed, press the SET key <p>Cautious) setting the year as the (- -) for every year within the start year, month and day will fix the end year as (- -) for every year.</p>
<p>⑤</p> 	<p>⑤ Start time setting</p> <ul style="list-style-type: none"> • Set the start time by using the hrs and min key but  key is only used when decreasing the previous value. • Once the start time setting is completed, press the SET key.
<p>⑥</p> 	<p>⑥ End time setting</p> <ul style="list-style-type: none"> • Set the end time by using the hrs and min key but  key is only used when decreasing the previous value. • Once the end time setting is completed, press the SET key
<p>⑦</p> 	<p>⑦ Return the yearly program setting</p> <ul style="list-style-type: none"> • Press the PROG key for more than 3 sec in order to return to the operation mode.
<ul style="list-style-type: none"> • Pressing the UP, DOWN key for more than 1 sec will change the time value instantly. • When setting the year, it can set the year up to 2 years from the current year. Example) if current year is 2008, it can be set as follows. — ⇒ 08 ⇒ 09 ⇒ 10 ⇒ — ⇒ 08 ⇒ . . . • When adding additional programs to the set program, please repeat steps from ② to ⑦ • In the state where yearly program is being set, it can additionally set the weekly program. • Yearly timer setting is composed of 4 STEP and once setting is completed then it will display the number of remaining STEP that can be set. 	

13.7 Yearly pulse operation

Example) Output ON for only 10 sec from 2008 sep8 to 2008 sep10 at 17:40

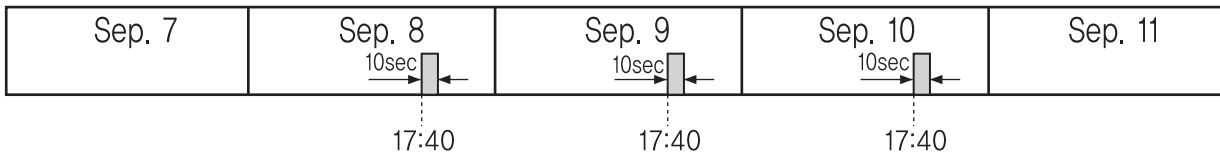

Parameter	Explanation
<p>①</p>	<p>① Enter into the Yearly program setting</p> <ul style="list-style-type: none"> • Within the operation mode, press the PROG key for more than 3sec to enter into the set mode and then press the PROG key one more time shortly then YE Ar will start to flicker. Here, press the SET key.
<p>②</p>	<p>② Operation mode setting</p> <ul style="list-style-type: none"> • Since it is in the timer operation mode, press the \blacktriangle or \blacktriangledown key to set the pulse operation mode. • Once the pulse operation setting is completed, press the SET key.
<p>③</p>	<p>③ Set the start year, month and day</p> <ul style="list-style-type: none"> • Set the start year, month and day by pressing the del, hrs and min key but \blacktriangledown key is applied when decreasing the previous value. • Once setting the start year, month and day are completed, press the SET key <p>Cautious) within the year, the "--" indication is a setting for every year.</p>
<p>④</p>	<p>④ Set the end year, month and day</p> <ul style="list-style-type: none"> • Set the end year, month and day by pressing the del, hrs and min key but \blacktriangledown key is applied when decreasing the previous value. • Once setting the end year, month and day are completed, press the SET key <p>Cautious) setting the year as the (- -) for every year within the start year, month and day will fix the end year as (- -) for every year.</p>
<p>⑤</p>	<p>⑤ Start time setting</p> <ul style="list-style-type: none"> • Set the start time by using the hrs, min key but \blacktriangledown key is only used when decreasing the previous value. • Once the start time setting is completed, press the SET key.
<p>⑥</p>	<p>⑥ Pulse time range setting</p> <ul style="list-style-type: none"> • Set the pulse time range by using the min key but \blacktriangledown key is only used when decreasing previous value. • Once the pulse time range setting is completed, press the SET key.

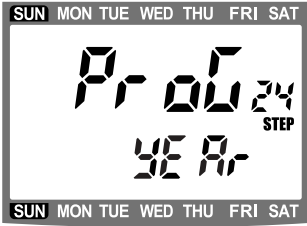

<p>⑦</p> 	<p>⑦ Return the yearly program setting</p> <ul style="list-style-type: none"> • Press the PROG key for more than 3 sec in order to return to the operation mode.
<ul style="list-style-type: none"> • Pressing the UP, DOWN key for more than 1 sec will change the time value instantly. • When setting the year, it can set the year up to 2 years from the current year. Example) if current year is 2008, it can be set as follows. — ⇒ 08 ⇒ 09 ⇒ 10 ⇒ — ⇒ 08 ⇒ . . . • When adding additional programs to the set program, please repeat steps from ② to ⑦. • In the state where yearly program is being set, it can additionally set the weekly program. • Yearly timer setting is composed of 4 STEP and once setting is completed then it will display the number of remaining STEP that can be set. 	

14 Program editing (Program setting group)

14.1 Weekly program edit

It is possible to check the program that had been set in the weekly program edit mode and use the same revising method as the weekly program setting.

In order to delete the set program individually in the weekly program edit mode, press the **del** key for 1 sec then *dEL* indication will start to flicker. Here, press the **SET** key to delete the program.

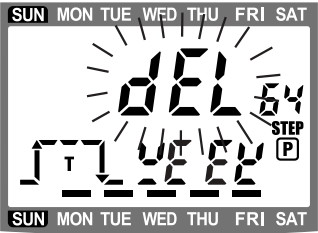

Parameter	Explanation
<p>①</p> 	<p>① Enter into the weekly program edit mode</p> <ul style="list-style-type: none"> • Enter into the operation mode by pressing the PROG key for more than 3 sec and repeatedly press the PROG key to turn ON the <i>Edit</i> indication and once the <i>YE EL</i> indication flickers, press the SET key.
<p>②</p> 	<p>② weekly program edit</p> <ul style="list-style-type: none"> • Revise it same as the weekly program setting method. – Displayed in the order of program input • Once the <i>End</i> indication flickers, it is indicating the completion of program edit. – Pressing the SET key will return to the EDIT mode.

	<p>③ weekly program delete</p> <ul style="list-style-type: none"> In order to individually delete the weekly program, press the del key for 1 sec then the “<i>dEL</i>” key will start to flicker. Here, press the SET key to delete the program.
<ul style="list-style-type: none"> Pressing the PROG key in the middle of revising the weekly program, it will cancel the work and return to the weekly program EDIT mode. Unable to revise the operation mode (timer, pulse, cycle) 	

14.2 Yearly program edit

It is possible to check the program that had been set in the yearly program edit mode and use the same revising method as the yearly program setting.

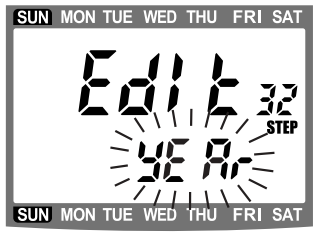
In order to delete the set program individually in the yearly program edit mode, press the **del** key for 1 sec then “*dEL*” indication will start to flicker. Here, press the **SET** key to delete the program.

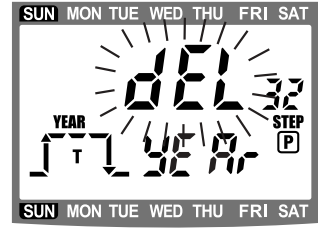
Parameter	Explanation
	<p>① Enter into the yearly program edit mode</p> <ul style="list-style-type: none"> Enter into the operation mode by pressing the PROG key for more than 3 sec and repeatedly press the PROG key to turn ON the “<i>Edit</i>” indication and once the “<i>YEAR</i>” indication flickers, press the SET key.
	<p>② Yearly program revise</p> <ul style="list-style-type: none"> Revise it same as the yearly program setting method. – Displayed in the order of program input Once the “<i>End</i>” indication flickers, it is indicating the completion of program edit. – Pressing the SET key will return to the EDIT mode.
	<p>③ Yearly program delete</p> <ul style="list-style-type: none"> In order to individually delete the yearly program, press the del key for 1 sec then the “<i>dEL</i>” key will start to flicker. Here, press the SET key to delete the program.
<ul style="list-style-type: none"> Pressing the PROG key in the middle of revising the yearly program, it will cancel the work and return to the yearly program EDT mode. Unable to revise the operation mode (timer, pulse). 	

15 Delete all programs

15.1 Delete all weekly programs

- Enter into the program setting mode by pressing the **PROG** key for more than 3 sec within the operation mode and repeatedly press the **PROG** key then “CLR” indication will be turned ON and “YEAR” indication will start to flicker. Here, press the **SET** key.
 –Pressing the **PROG** key one more time can delete all of yearly program (“YEAR” indication flickers)
- Pressing the **SET** key for more than 3 sec will only erase the program in the selected port. (“End” indication means complete of work)



15.2 Delete all yearly programs

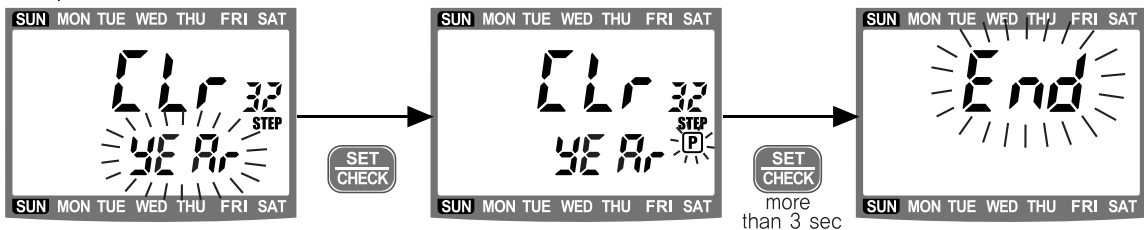

- Enter into the program setting mode by pressing the **PROG** key for more than 3 sec within the operation mode and repeatedly press the **PROG** key then “CLR” indication will be turned ON and “YEAR” indication will start to flicker. Here, press the **SET** key.
- Pressing the **SET** key for more than 3 sec will only erase the program in the selected port. (“End” indication means complete of work)

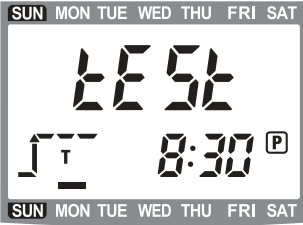

16 Program test

Able to check the actual time and day for output start and output end about the set weekly program for 1 week period.

Parameter	Explanation
① 	① Enter into the program test setting • Enter into the program setting mode by pressing the PROG key for more than 3 sec within the operation mode and repeatedly press the PROG key until “TEST” indication starts to flicker. Here, press the SET key.
② 	② Start time indication • “TEST” indication flickers and the start time regarding the first output operation time will be displayed. • In this state, pressing the SET key will display the end time.

<p>③</p> 	<p>③ End time indication</p> <ul style="list-style-type: none"> • “E E S E” indication flickers and the end time regarding the first output operation time will be displayed. • In this state, pressing the SET key will display the next output operation time.
<p>④</p> 	<p>④ End the program test</p> <ul style="list-style-type: none"> • Able to check the output operation time for 1 week period by pressing the SET key repeatedly • Once the output operation time of set program completed, “End” indication will flicker.



17 Function setting (function setting group)

17.1 Current time setting (Refer to the time adjustment method Page 16~17)

17.2 Yearly holiday setting

Without changing the program it blocks the output by assigning the yearly holiday date. Users do not have to change the set program or operate the switch forcedly because once the yearly holiday setting date passes, it automatically cancels the function.



Example) set holiday from 2008/7/30 to 8/3 and in the next year, it will be cancelled.

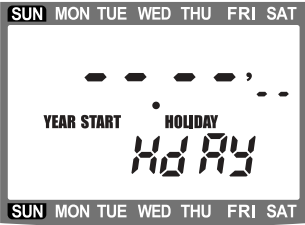

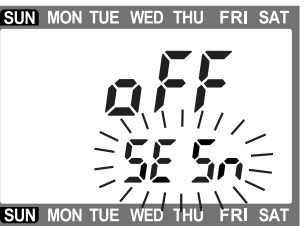
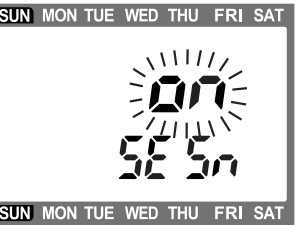

Parameter	Explanation
<p>①</p> 	<p>① Enter into the yearly holiday setting</p> <ul style="list-style-type: none"> • Enter into the function setting mode by pressing the FUNT key for more than 3 sec within the operation mode and pressing the PROG key one more time will flicker the “Hd Ry”. Here, press the SET key.
<p>②</p> 	<p>② Yearly holiday end year, month and day setting</p> <ul style="list-style-type: none"> • Set the start year, month and day by using the del, hrs and min key. But, (▼) key is applied when decreasing the previous value. • “START” indication flickers. • Once completing the start year, month and day setting, press the SET key. Cautious) in the year, “--” indication is yearly setting.

<p>③</p> 	<p>③ Yearly holiday end year, month and day setting</p> <ul style="list-style-type: none"> • Set the end year, month and day by pressing the del, hrs and min key but \blacktriangledown key is applied when decreasing the previous value. • “STOP” indication flickers. • Once completing the end year, month and day, press the SET key (Cautious) setting the year as the (–) for every year within the start year, month and day will fix the end year as (–) for every year
<p>④</p> 	<p>④ Return to the yearly holiday setting</p> <ul style="list-style-type: none"> • “- - - -” indication flickers, users can perform additional setting. • In order to return to the operation mode, press the PROG key for more than 3 sec.
<ul style="list-style-type: none"> • Yearly holiday setting can be set from current date to date after 2 years 12/31 and once passes the assigned date, it will automatically cancel the function. • Able to set 16 times for the yearly holiday setting and if it is already being set, it will display with the current program and able to set additionally by pressing the SET key until “- - - -” is displayed. (able to revise the yearly holiday) • In order to delete the holiday setting, press the del key for 1 sec then “DEL” will flicker. Here, press the SET key to delete the program. 	

17.3 Season switch setting

Depending on the season switch setting, weekly program automatically changed.

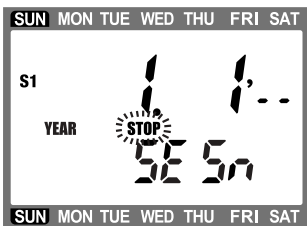
Parameter	Explanation
<p>①</p> 	<p>① Enter into the season switch setting</p> <ul style="list-style-type: none"> • Enter into the function setting mode by pressing the FUNT key for more than 3 sec within the operation mode and move to the “SE Sn” setting screen by pressing the PROG key repeatedly. • Once the “SE Sn” indication is displayed, press the SET key.
<p>②</p> 	<p>② Season switch setting selection</p> <ul style="list-style-type: none"> • Change OFF indication to the ON indication by using \blacktriangle or \blacktriangledown key. • Once setting is completed, press the SET key.
<p>③</p> 	<p>③ Season period setting</p> <ul style="list-style-type: none"> • Move to the season period setting mode by pressing the PROG key. • Since it is in the season period setting mode, press the SET key.



<p>④</p> 	<p>④ Season selection</p> <ul style="list-style-type: none"> • Select the season among S1, S2, S3 and S4 by using \blacktriangle or \blacktriangledown. • Once selecting the season, press the SET key.
<p>⑤</p> 	<p>⑤ Start month and day setting</p> <ul style="list-style-type: none"> • Set the start month and day by using the hrs and min key, but \blacktriangledown key is only used when decreasing previous value. • START indication flickers • Once the start month and day setting is completed, press the SET key.
<p>⑥</p> 	<p>⑥ End month and day</p> <ul style="list-style-type: none"> • Set the end month and day by using the hrs and min key, but \blacktriangledown key is only used when decreasing previous value. • STOP indication flickers • Once the end month and day setting is completed, press the SET key.
<p>⑦</p> 	<p>⑦ Return to the season switch setting</p> <ul style="list-style-type: none"> • In order to return to the operation mode, press the PROG key for more than 3 sec.





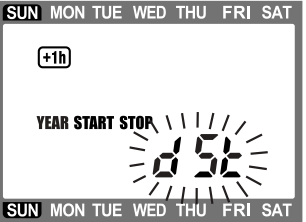
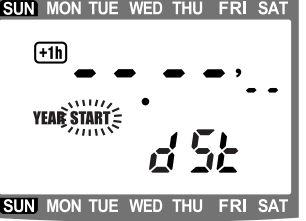

• Season switch setting is for the weekly program. (Not yearly program).
 Cautious) if the weekly program had already been set, changing the season switch setting from OFF to ON or ON to OFF will delete the all settings in the weekly program so please be cautious.

• If season period duplicated, it goes as following order. S1<S2<S3<S4
 Example) Set S1 (1/1~12/31), S2 (7/20~8/1) then it goes as following order.
 S1 (1/1~7/19) < S2 (7/20~8/31) < S1 (9/1~12/31)

17.4 Summer time setting

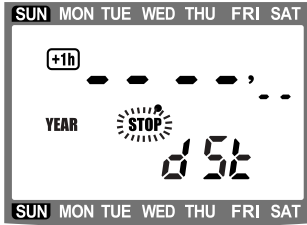
Switching manually or switching automatically are possible in the summer time setting. Setting the automatic switching period (time) will provide more convenient usage.



Parameter	Explanation
<p>①</p> 	<p>① Enter into the summer time setting</p> <ul style="list-style-type: none"> • Enter into the function setting mode by pressing the FUNT key for more than 3 sec within the operation mode and move to the 'dst' setting screen by pressing the PROG key repeatedly. • Once "dst" is indicated, press the SET key
<p>②</p> 	<p>② Summer time selection</p> <ul style="list-style-type: none"> • Change OFF indication to the AUTO indication by using ▲ or ▼ key. • Once setting is completed, press the SET key
<p>③</p> 	<p>③ Summer time period setting</p> <ul style="list-style-type: none"> • Move to the summer time period setting mode by pressing the PROG key. • Since it is in the summer time period setting mode, press the SET key
<p>④</p> 	<p>④ Start month and day setting</p> <ul style="list-style-type: none"> • Set the start month, day by using the hrs and min key but ▼ key is only used when decreasing previous value. • START indication flickers • Once completing the start month and day setting, press the SET key

<p>⑤</p> 	<p>⑤ Start time setting</p> <ul style="list-style-type: none"> • Set the start time by using the hrs key but  key is only used when decreasing previous value. • Once completing the start time setting, press the SET key
<p>⑥</p> 	<p>⑥ End month and day setting</p> <ul style="list-style-type: none"> • Set the end month, day by using the hrs and min key but  key is only used when decreasing previous value. • STOP indication flickers • Once completing the end month and day setting, press the SET key
<p>⑦</p> 	<p>⑦ End time setting</p> <ul style="list-style-type: none"> • Set the end time by using the hrs key but  key is only used when decreasing previous value. • Once completing the end time setting, press the SET key
<p>⑧</p> 	<p>⑧ Return to the summer time setting</p> <ul style="list-style-type: none"> • In order to return to the operation mode, press the PROG key for more than 3 sec.
<ul style="list-style-type: none"> • External +1h key will not operate in case summer time is set as "AUTO". • It is available to check or change the summer time period which is set previously. • In case of Start time setting and End time setting, the value of [MIN] is fixed as "00 MIN" 	

18 Simple function (use front panel key)



18.1 Summer time external input

In the operation mode, pressing the **+1h** key for more than 1 sec will make the time either one hour faster or slower.

Parameter	Explanation
<p>①</p>  <p>↓ ↑ </p> <p>②</p> 	<p>① Summer time application</p> <ul style="list-style-type: none"> In the operation mode, pressing the +1h key for more than 1 sec will turn ON the “+1h” indication and the current time will become 1 hour faster. <p>② Summer time cancellation</p> <ul style="list-style-type: none"> In the operation mode, pressing the +1h key for more than 1 sec will turn OFF the “+1h” indication and the current time will become 1 hour slower
<p>• Summer time can be set as yearly type (refer to the summer time setting Cautious) if setting the summer time as ON, “+1h” the key will not be operated</p>	



18.2 12/24h indication switch

In the operation mode, every time when you press the **12/24h** key for more than 1 sec, it will change the current time displaying method.

파라미터	Explanation
<p>①</p>  <p>↓ ↑ </p> <p>②</p> 	<p>① 24 hour display => AM/PM 12 hour display</p> <ul style="list-style-type: none"> In the operation mode, pressing the 12/24h key for more than 1 sec will change from “24hour display” type to the “AM/PM 12 hour display” type. <p>② AM/PM 12 hour display => 24 hour display</p> <ul style="list-style-type: none"> In the operation mode, pressing the 12/24h key for more than 1 sec will change from “AM/PM 12 hour display” type to the “24 hour display” type.
<p>• Time display type in the operation mode: 24h display type => 0:00~23:59, 12h display type => AM 0:00~11:59 / PM 0:00~11:59</p>	

18.3 Screen display switch

Pressing the **m.d** key for 1 sec in the operation mode will change the information in the display 2

Parameter	Explanation
<p>①</p>  <p>↓ m.d</p> <p>②</p> 	<p>① Current month/date display</p> <ul style="list-style-type: none"> • Display 1 : Current time display (hour, min, sec) • Display 2 : Current month/date display (month, date) <hr/> <p>② Display the operation time after generating the output</p> <ul style="list-style-type: none"> • Display 1 : Current time display (hour, min, sec) • Display 2 : Display the operation time after generating the output (hour, min)
<ul style="list-style-type: none"> • Default setting is “current month and date” • After setting the program, the set value on the display 2 screen will be applied within the operation mode. (current month and date display) 	



1381-3, Juan-Dong, Nam-Gu, Incheon, Korea
TEL. +82-32-876-4697 FAX. +82-32-876-4696
<http://www.hynux.net> E-mail. overseas@hynux.com